



LITPA LED





LİTPA Lighting was founded in 1992 with the sole intention of ensuring the manufacture and direct marketing of quality lighting solutions through its extensive and quality range of lighting fixtures. Our mission is to provide lighting solutions for indoor and outdoor settings that are not only reasonably priced, but due to our high-quality engineering and extensive research veritably “light-up your lives”.

LİTPA seeks to provide not only suitable materials for use in its production, but also to ensure that it meets the lighting needs of the space in which it will be situated. For this reason, material quality that will meet the relevant lighting criteria alone is not enough. We also seek to fulfill the following criteria for our lighting solutions; that our fixtures must ensure viewing optimization, enhance and optimize the aesthetic value of the area in which fixtures are to be placed, ensure ease of mounting, wear-resistance appropriate to the conditions, suitability to the electrical supply; while also providing lighting comfort of the space to users, easy maintenance and economical usage. All of these considerations have been made in advance for you by our advanced and highly dedicated staff.







Our meticulous quality-control and attention to detail at every stage of the manufacturing process is of the utmost importance in our adherence to global standards. Every item, from the materials we use for products that we produce is checked to ensure the highest specifications of quality and performance.

Our company has placed a great deal of importance to its R&D (Research and Development) also, hence our dedicated, experienced and energetic team of professionals seeks always to surpass itself in provision of product and service delivery to our clients. With one call, we seek to be as close as possible to our clients – wherever they are and no matter where our offices are. LİTPA's progressive approach, values and guidelines has led to success with Turkey 's global corporations and business.

OUTDOOR LIGHTING

STREET LIGHTING 4 - 5		FLOODLIGHT 6 - 7		WALLWASHER 8 - 9	
	GROUND RECESSED 10 - 11		GARDEN LIGHTING 12 - 15		WALL (OUTDOOR) 16 - 17

INDOOR LIGHTING

DOWNLIGHT 20 - 31		OFFICE 32 - 41		ANTIBACTERIAL 42 - 43	
	LINEAR 44 - 47		DECORATIVE 48 - 53		WALL (INDOOR) 54 - 59
INDUSTRIAL 60 - 61					

OUTDOOR LIGHTING FIXTURES





Street Lighting

STREETRAY

IP66

Streetray is a highly efficient IP66 protection class road lighting fixture which using LED technology. Our fixtures are produced in three different types as Mini, the Midi and Maxi. In this way, they can be utilized in a wide range from 2,900 lumens to 27,000 lumens.

STREETRAY road fixtures can be used in all areas of road lighting including M1 motorways, urban street lighting and lighting of alleys. Its monolithic integrally cooled die-cast aluminum body structure extends the life of light source and reduces maintenance costs. Streetray also offers many features such as angle adjustable mounting bracket, channel water management and bird repeller which can optionally be installed. The fixture's body is designed to be suitable for all kinds of urban automation. Automation systems which can be used in Wi-Fi, Zigbee, RF, PLC, Dali, KNX systems are also available upon request.

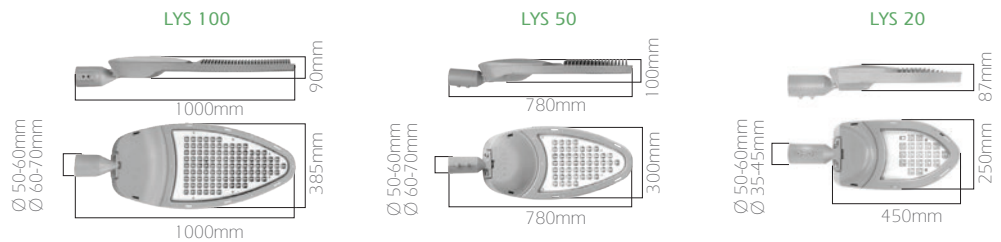

LYS 24V/DC Optional Solar System

Code	LYS 100 (Maxi)	LYS 50 (Midi)	LYS 20 (Mini)	LYS 20/DC (Solar)
LED	High Efficiency Power LEDs			
System Power	130 W	62 W	23 W	22 W
	170 W	85 W	32 W	33 W
	180 W	117 W	46 W	48 W
	230 W	127 W	72 W	
Light Flux	15,400 lm	7,240 lm	2,910 lm	2,910 lm
	20,100 lm	10,060 lm	4,020 lm	4,020 lm
	20,800 lm	13,500 lm	5,400 lm	5,400 lm
	27,000 lm	13,700 lm	7,610 lm	
Colour Temperature	4000 - 5000 - 6500 K			
Voltage	220V - 50Hz			24 VDC
Body	Aluminum injection			
Optic	High-efficiency lens			
Cooler	Cooling from the surface of the aluminum body			
Glass	5 mm thick tempered and serigraphy printed			
Accessory	Anti-corosive cover			
Colour	Grey			
Box Dimensions	102x40x12cm	78x33x13cm	60x26x12cm	60x26x12cm
Weight	15.200 gr	9.800 gr	5.700 gr	5.700 gr

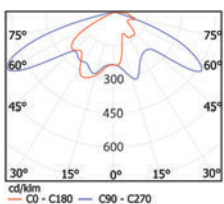

Pedestrian Areas & Walkways

RINGA

IP65



RNY4



RNY2

Ringa, which in particular is preferred in parks, gardens, walking trails and residential areas, has been designed with the purpose of bringing diversity to the external environment thanks to the aesthetic design thereof. The aluminum body is manufactured according to protection class IP66 to be resistant to outdoor conditions. Usage height is on 4 to 6 meters high pole while way of mounting is on the top of a Ø60 pole.

Highly efficient LEDs have been used and optimum drive currents have been preferred in Ringa fixtures in order to save energy. Ringa, designed to prevent light from escaping into the sky, has been designed also to prevent light pollution by virtue of this feature.



Code	RNY 2/70	RNY 4/70	RNY4/100	RNY4/140
LED	High Efficiency Power LEDs			
System Power	70 W	70 W	100 W	142 W
Light Flux	7650 lm ~ 15000 lm			
Colour Temperature	3000 - 4000 - 5000 - 5700 - 6500 K			
Voltage	220V - 50Hz			
Body	Aluminum injection painted with electrostatic paint			
Cooler	Cooling from the surface of the aluminum body			
Optic	High Efficiency lenses; 21° - 26° - 45° - 65° - (21°+37°) or reflectors; 21° - 30° - 63° - 90°			
Glass	Clear Glass, serigraphy printed			
Accessory	Apparatus for pole mounting			
Colour	Grey or RAL Color			
Box Dimensions	70x65x35 cm	70x65x70 cm	70x65x70 cm	70x65x70 cm
Weight	9.800 gr	12.800 gr	12.800 gr	12.800 gr

Symmetrical Reflector

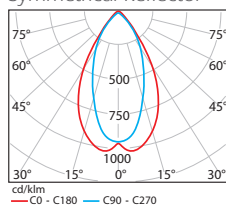

Asymmetrical Reflector

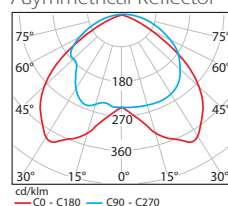



HERCULED

IP66

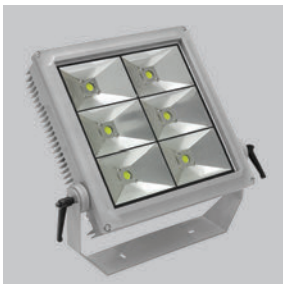

HCL/S
Symmetrical

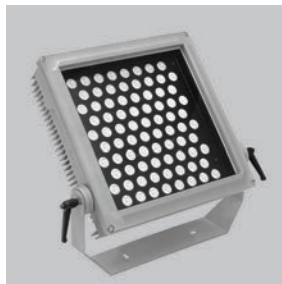

AREA



HCL/P

Herculed projectors can be used as white, red, green, blue and yellow light colors or as RGB in particular for outdoor lighting. It is possible put on and off, dim and manage many fixtures with different scenarios from a single point by the DMX system specially produced by Litpa.

Herculed/ Area provides excellent and efficient solutions for different optical structures and standard area lighting while Herculed/Power meets all kinds of lighting requirements in high poles, facades and more precise lighting. Herculed/Basic offers RGB option and is ideal for decorative facade solutions.



HCL/AS
Asymmetrical



HCL/PRO

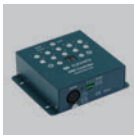

DMX Controller

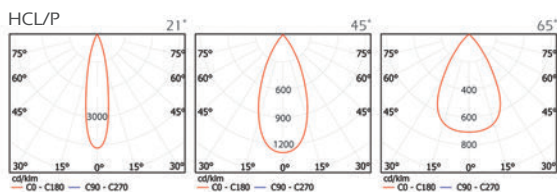
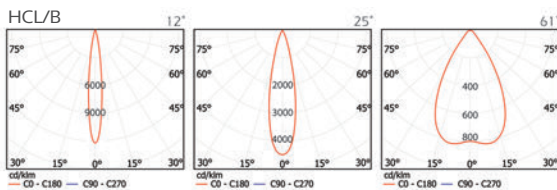
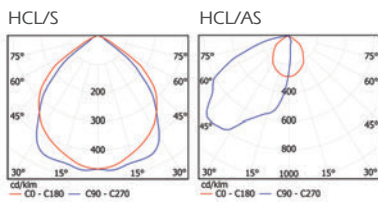
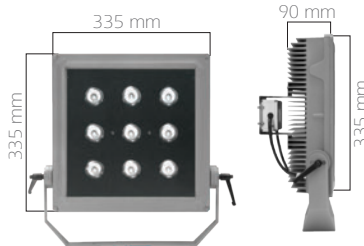

Code	HCL/S HCL/AS	HCL/B	HCL/P	HCL/PRO
LED	High-Efficiency COB Led	High-Efficiency Power Led	High-Efficiency Multi-Power	High-Efficiency Multi-Power
System Power	65 W 92 W 116 W 185 W	45 W 65 W 90 W 135 W	80 W (3x3) 137 W (4x4) 185 W (5x5)	65 W 130 W 210 W
Light Flux	6,000 lm 8,500 lm 10,000 lm 18,000 lm	4,480 lm 6,800 lm 8,960 lm 12,600 lm	8,500 lm 15,200 lm 19,000 lm	RGBW
Colour Temperature	3000 K 4000 K 5000 K	3000-4000 5000K-RGB R-G-B-A	3000-4000 5000K- R-G-B-A	RGBW
Voltage	220V - 50Hz			
Body	Aluminum injection			
Diffuser	Impact Resistance tempered glass with side sare serigraphy printed			
Optic	Miro-Silver aluminum	12° - 25°- 61° High Efficiency lens	21° - 45°- 65° High-Efficiency lens	9° - 28°- (42°+30°)
Box Dimensions	44x48x19cm	44x48x19cm	44x48x19cm	44x48x19cm
Weight	11.500 gr	12.000 gr	12.100 gr	12.000 gr

Rotational Floodlights

RTL

IP65



RTL 24



RTL 18



RTL 12



RTL 9



Louvre



DMX Controller



RTL projectors are manufactured with optical structure which can provide light from 10 ° to 45 ° in lighting of columns and wall surfaces. LEDs in white, red, green, blue and RGB colors are used and it is possible put on and off, dim and manage many fixtures with different scenarios from a single point by the DMX system specially produced by Litpa.

Projectors increase the efficiency in projects to the highest level with different power options. Mounting feet which can move gradually in low angle are designed to direct the fixture to the areas where focusing will be made. Aluminum body is painted to be resistant to the corrosive effects caused by the external environment conditions.

RTL 9 - 12

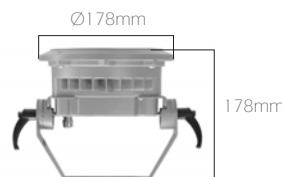

RTL 18 - 24

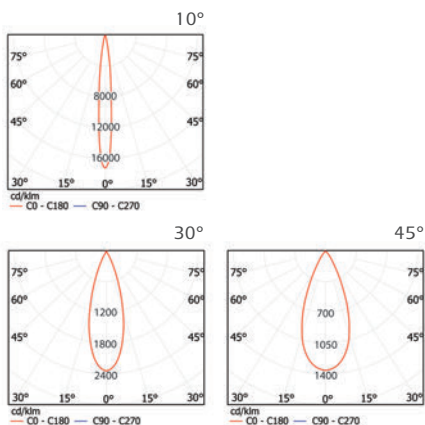
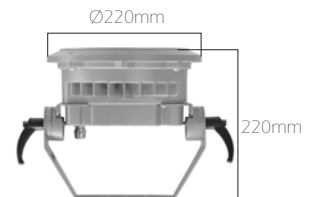

Code	RTL 9	RTL 12	RTL 18	RTL 24
LED	High efficient Mid-Power LED			
System Power	12,7 W	15,8 W	22,2 W	27,8 W
Light Flux	820 lm	1,100 lm	1,650 lm	2,200 lm
Colour Temperature	3000-4000-5000K, R-G-B-Amber, RGB			
Voltage	220V - 50Hz			
Body	Aluminum injection painted with electrostatic paint			
Cooler	Cooling from the body surface			
Optic	Impact resistance tempered glass and high efficient lenses			
Frame	Aluminum injection			
Colour	Grey			
Accessory	Standard cable or IP68 connector			
Box Dimensions	25x19x17cm		28x23x17cm	
Weight	2.500 gr	2.600 gr	3.100 gr	3.200 gr

Wallwasher

LINEALED

IP65

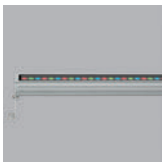

LDW/RGB



DMX Controller

Linealed is a wall washer type of fixture produced for use in façade lighting. They can be used as white, red, green, blue, yellow and RGB to get the desired effect on the surface. DMX systems allow the realization of different scenarios for the fixture from one single center. It is possible to direct the area to light properly by virtue of the lens types that can be used at different angles.

The channeled aluminum body structure of the fixture, which can transfer heat in the best way, keeps the LEDs in low ambient temperatures and maximizes their lives. Silicone gasket placed between the injection end cover is provides IP65 protection class.

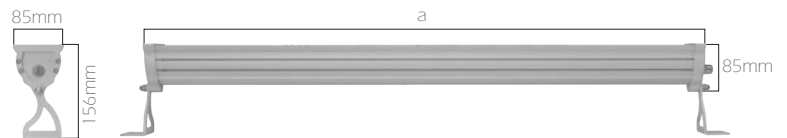

Code	a
LDW 30	340 mm
LDW 60	640 mm
LDW 90	940 mm
LDW 120	1.240 mm

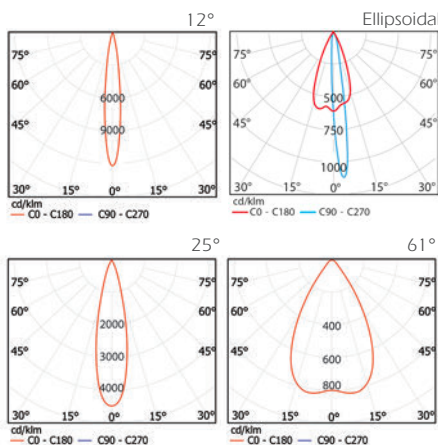

Code	LDW 30	LDW 60	LDW 90	LDW 120
LED	High efficient Power LED			
System Power	15 W	30 W	45 W	60 W
Light Flux	1,160 lm	2,340 lm	3,500 lm	4,850 lm
Colour Temperature	3000-4000-5000-6500K / R-G-B-Amber / RGB			
Voltage	220V - 50Hz			
Body	Aluminum extrusion			
Cooler	Cooling from the body surface			
Diffuser	4mm thick and tempered, ground with serigraphic printing			
Optic	High efficient lens			
Lens Angle	12° - (14°+39°) - 25° - 46° - 61°			
Colour	Grey			
Accessory	Standard cable or IP68 connector			
Box Dimensions	11x16x43cm	11x16x73cm	11x16x103cm	11x16x133cm
Weight	1.900 gr	3.200 gr	4.300 gr	7.000 gr

Wallwasher

SKYLINE

IP65



Wallwasher type SKYLINE fixture which is an indispensable fixture of facade lighting does not harm the aesthetic appearance of the facade thanks to the slim and elegant structure thereof. The foot structure which moves along the fixture provides ease of installation while fixture efficiency is at the highest level thanks to powerful LEDs and lenses with high permeability.



LSW/RGB



DMX Controller

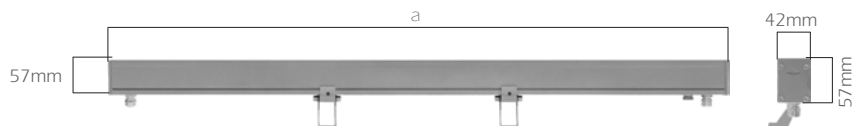

Code	a
LSW 50	510 mm
LSW 100	1.010 mm

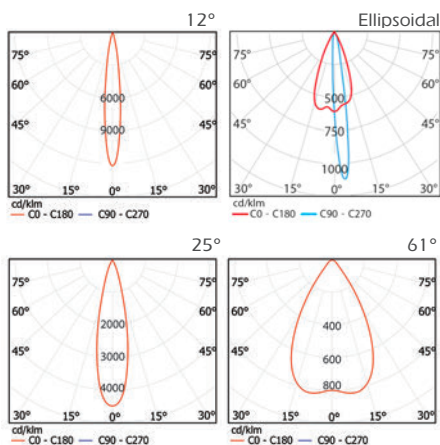

Code	LSW 50	LSW 100
LED	High efficient Power LED	
System Power	21 W	39 W
Light Flux	2,000 lm	4,000 lm
Colour Temperature	3000 - 4000 - 5000 K / R-G-B / RGB	
Voltage	220V - 50Hz	
Body	Aluminum extrusion	
Cooler	Cooling from the body surface	
Lens Angle	12° - (14°+39°) - 25° - 46° - 61°	
Diffuser	4mm thick and tempered, ground with serigraphic printing	
Optic	High efficient lenses	
Colour	Grey	
Accessory	Standard cable or IP68 connector	
Box Dimensions	52x5x11 cm	102x5x11 cm
Weight	1.550 gr	2.500 gr



HADES

IP67

Ground recessed fixture series named HADES fixtures are designed for use in interior and exterior spaces and are extremely efficient fixtures for lighting of facades, walls, columns, and trees. High efficiency LEDs increase the life of the fixtures and eliminates the heating problems.

These fixtures are resistant to shock thanks to especially reinforced glass structures thereof. They can be produced in desired light color temperature and in different light colors. They are able to create the desired aesthetic effect in the area by being connected to the DMX control unit and by using as RGB.



HYL 9



HYL 12

HYL 18



HYL OP



HYL 24



DMX Controller

HYL 9 - 12



HYL 18 - 24

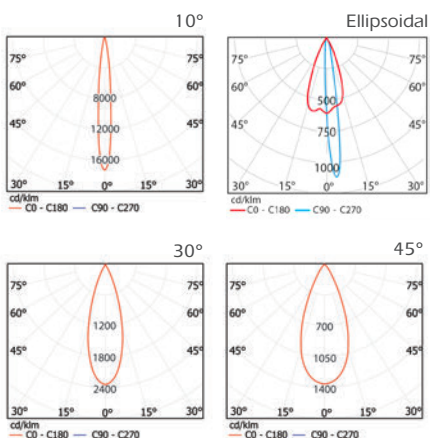

Code	HYL 9	HYL 12	HYL 18	HYL 24
LED	High efficient Power LED			
System Power	13 W	16 W	22 W	28 W
Light Flux	1,200 lm	1,650 lm	2,480 lm	3,300 lm
Colour Temperature	3000-4000-5000-6500 K, R-G-B-Amber, RGB			
Voltage	220V - 50Hz			
Body	Aluminum injection			
Cooler	Cooling from the body surface			
Lens Angle	10° - (14°+39°) - 30° - 45°			
Optic	Impact resistance tempered glass and high efficient lenses			
Accessory	Standard cable or IP68 connector			
Box Dimensions	26x26x25cm		32x32x27cm	
Weight	2.500gr	2.600gr	3.200gr	3.300gr

Ground Recessed

YLW

IP67



These highly efficient linear fixtures can be used as ground recessed fixtures in interior and exterior lighting. They have a long lifetime thanks to their stainless steel frames, highly resistant heat-treated glasses and corrosion resistant aluminum bodies that can transfer heat easily. Different LEDs can create the color temperature of the light generated in the fixture. They can be used as RGB by connecting to the DMX control unit.



DMX Controller

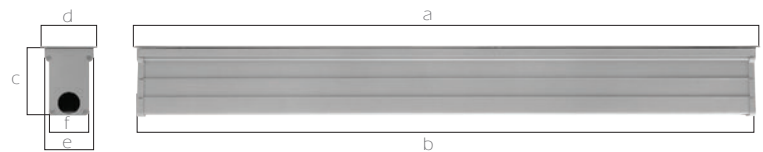

Code	a	b	c	d	e	f	Cut-Out
YLW 40	402 mm	390 mm	107 mm	90 mm	80 mm	65 mm	82X395mm
YLW 70	562 mm	550 mm	107 mm	90 mm	80 mm	65 mm	82X555mm
YLW 100	1058 mm	1046 mm	107 mm	90 mm	80 mm	65 mm	82X1050mm

Code	YLW 40	YLW 70	YLW 100
LED	High efficient Power LED		
System Power	15 W	21 W	40 W
Light Flux	1.210 lm	2.420 lm	3.630 lm
Colour Temperature	3000-4000-5000-6500K,R-G-B-Amber,RGB		
Voltage	220V - 50Hz		
Body	Aluminum extrusion		
Cooler	Cooling from the aluminum body surface		
Lens Angle	12° - (14°+39°) - 25° - 46° - 61°		
Diffuser	Impact resistance tempered glass with 8mm thickness		
Optic	High efficient lenses		
Frame	Stainless steel		
Accessory	Standard cable or IP68 connector		
Box Dimensions	42x12x10 cm	58x12x10 cm	108x12x10 cm
Weight	2.230 gr	3.350 gr	6.250 gr

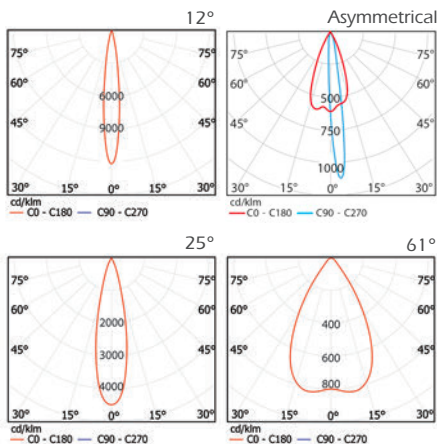



Bollard

BOLLARD

IP54

Our bollards which can also be made of teak wood have been currently developed to become a model to draw your attention for outdoor applications with the aesthetic appearance thereof. They are preferred in various areas of application such as lighting of walking trails, parks, recreational areas, residential areas, outside the stadiums and etc.

Highly efficient LED systems have been used in this product like in all of our LED products. System power is within the range of 15 W to 22 W and the product life has been extended by easy installation and maintenance.

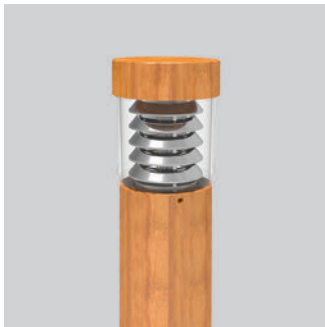

BYA-AC

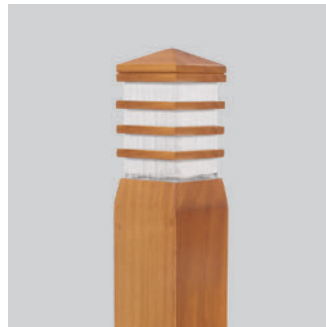

BKA-P



BYA-OP



8040



8050



Wood and metal bollard dimensions are the same

Code	BYA-AC	BYA-OP	BKA-P	8040-8050
LED	High efficient Mid-Power LED			
System Power	15 ~ 22 W			
Light Flux	800 ~ 900 lm			
Colour Temperature	3000 - 4000 - 5000 K - R-G-B			
Voltage	220V - 50Hz			
Body	Teak wood			Aluminum
Diffuser	Opal or Prismatic			
Box Dimensions	21x21x104 cm			
Weight	11.000 gr			5,200 gr

Garden Lighting

D-LFA / D-LFB

IP65



D-LFB9



D-LFK9



D-LFA4



D-LFK4



D-LFA3



D-LFK3

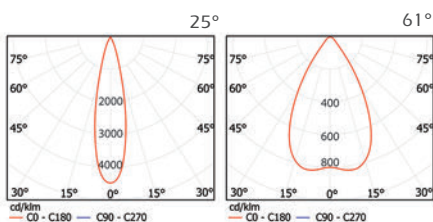
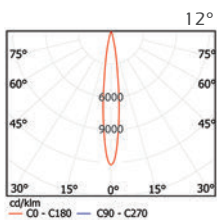

Special lighting system designed with high efficiency LED technology within range of 3 to 9 W for outdoor applications. Can also be employed in architectural garden lighting, tree lighting and for highlighting details.

Durability in all kinds of outdoor conditions thanks to corrosion-resistant cast aluminum outer body thereof. Two different types of mounting options are offered. The models include the type with foot anchored to the ground and the type with foot driven into the ground.

D- LFA3

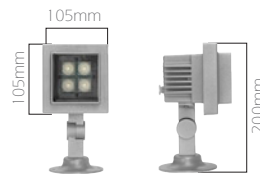

D- LFA3 and D- LFA4 dimensions are the same.

D- LFK4

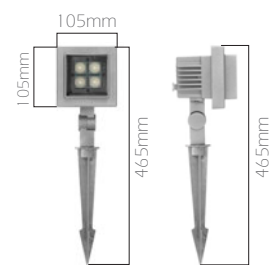

D- LFK9

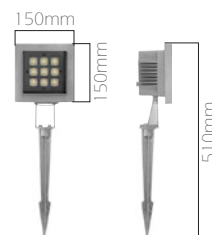

Code	D-LFA3 / D-LFK3	D-LFA4 / D-LFK4	D-LFB9 / D-LFK9
LED	High efficient Power LED		
System Power	4 W	5,5 W	12 W
Light Flux	260 lm	350 lm	800 lm
Colour Temperature	3000 - 4000 - 5000 K, R-G-B - Amber		
Voltage	220V - 50Hz		
Body	Aluminum injection painted with electrostatic paint		
Cooler	Cooling from the body surface		
Lens Angle	12°, 25°, 29°, 61° Lens		
Glass	3 mm thickness tempered		
Colour	Grey		
Box Dimensions	15x15x20cm 15x15x30cm	15x15x20cm 15x15x30cm	18x18x25cm
Weight	800 gr	800 gr	1.590 gr



Garden Lighting

LSH

IP65



Special lighting system designed with high efficiency LED technology to be utilized in outdoor applications. Used for architectural outdoor lighting, lighting for low trees and plants and water surface illumination in rivers and lakes.

Durability in all kinds of outdoor conditions thanks to corrosion-resistant cast aluminum outer body thereof. Prevents glare by virtue of aluminum and special light limiter. Aluminum foot is produced for assembly at the desired height between 30 and 90 cm. Can be used with metal plate which can be mounted from 4 points and which can be produced in the desired size with special stakes which can be driven into the ground.

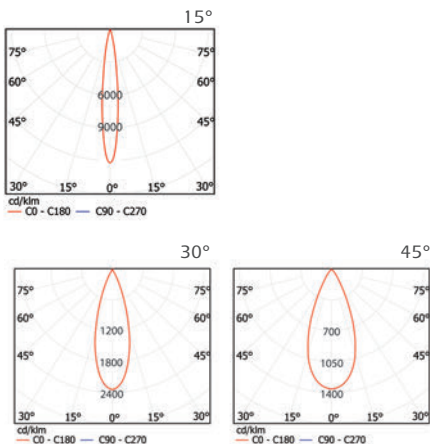
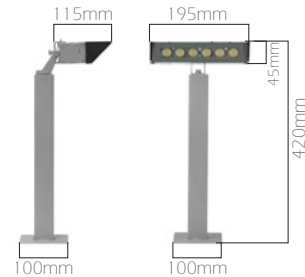

Code	LSH
LED	High efficient Power LED
System Power	8 W
Light Flux	720 lm
Colour Temperature	3000 - 4000 - 5000 K, R-G-B - Amber
Voltage	220V - 50Hz
Body	Aluminum injection painted with electrostatic paint
Cooler	Cooling from the body surface
Lens Angle	15° - 30° - 45°
Glass	4 mm thick and tempered glass
Colour	Grey
Box Dimensions	22x21x43cm
Weight	1.100 gr

Flowers / Grass Lighting

MSH

IP65



Special indirect lawn and garden lighting system designed with high efficiency LED technology within range of 3 to 9 W for outdoor applications. The system is preferred in architectural applications generally thanks to the indirect light beam coming from the module. Bright white paint with reflective properties has been used in the interior body paint with an eye to benefit maximum from the light coming from the LED modules.

MSH model Grass Fixtures can be employed for lighting lawn and garden plants and highlighting details in architectural garden lighting. Color options are available with a view to provide different light effects. Length of the fixture can be arranged according to the desired height.

Durability in all kinds of outdoor conditions thanks to corrosion-resistant injection molded aluminum outer body thereof. Has a long life by virtue of the injection molded aluminum with IP65 protection degree and does not require maintenance thanks to the LED module thereof. It can provide different applications with its free standing model and with the model which can be driven into the ground.

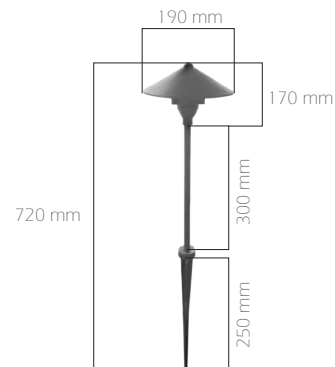

Code	MSH
LED	High efficient Power LED
System Power	3 - 9 W
Light Flux	50 - 200 lm
Colour Temperature	3000 - 4000 - 5000 K / R-G-B
Voltage	220V - 50Hz
Body	Aluminum injection LED modul
Lens	Lenses with opal diffuser effect
Glass	3 mm thick and tempered glass
Colour	Grey

D-LWA

IP65

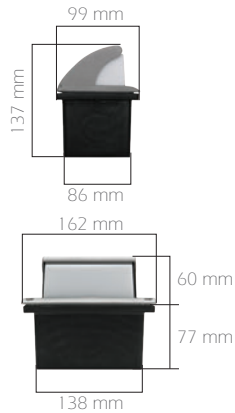

Code	D-LWA
LED	High efficient Mid-Power LED
System Power	8 W
Colour Temperature	3000 - 4000 - 5000 K
Voltage	220V - 50Hz
Body	Aluminum injection
Diffuser	2 mm acrylic lens
Cooler	Aluminum
Colour	Grey
Box Dimensions	20x18x14 cm
Weight	880 gr

D-LWK / D-LWK mini

IP65-IP20

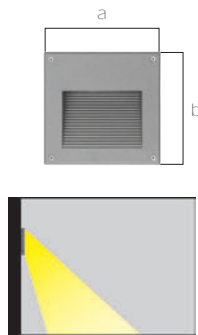

Code	a	b	Cut-Out
D-LWK	160mm	160mm	-
D-LWK mini	90mm	90mm	73X73mm

Code	D-LWK	D-LWK mini
LED	High efficient Mid-Power LED	
System Power	6 W	2 W
Colour Temperature	3000 - 4000 - 5000 K	
Voltage	220V - 50Hz	
Body	Aluminum injection	
Cooler	Aluminum	
Diffuser	2 mm acrylic lens	
Colour	Grey, Black	
Box Dimensions	20x20x13 cm	10x10 cm
Weight	920 gr	510 gr

D-LWD

IP65

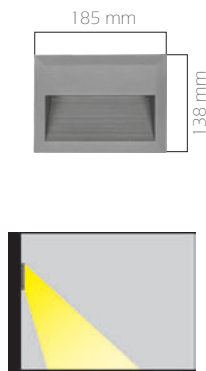

Blind Casing Dimensions: 174 x 130 x 84 mm

Code	D-LWD
LED	High efficient Mid-Power LED
System Power	7 W
Colour Temperature	3000 - 4000 - 5000 K
Voltage	220V - 50Hz
Body	Aluminum injection
Diffuser	2 mm acrylic lens
Colour	Grey
Box Dimensions	19x14x100 cm
Weight	1.000gr

D-LSD

IP65

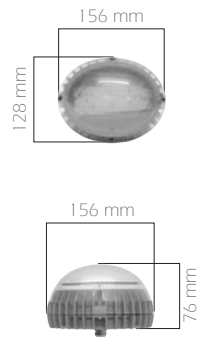

Code	D-LSD
LED	High efficient Mid-Power Led
System Power	8 W
Colour Temperature	3000 - 4000 - 5000 - 6500 K
Voltage	220V - 50Hz
Body	Aluminum injection
Diffuser	Acrylic transparent lens
Cooler	Cooling from the body surface
Colour	Grey
Box Dimensions	13x15x18 cm
Weight	650 gr

D-LYD

IP65



Code	D-LYD
LED	High efficient Mid-Power and COB Led
System Power	5W
Colour Temperature	3000 - 4000 - 5000 - 6500 K, RGB
Voltage	220V - 50Hz
Body	Aluminum injection
Lens	Opal
Cooler	Cooling from the body surface
Colour	Grey
Box Dimensions	13x15x12 cm
Weight	450 gr

D-OLS

IP65

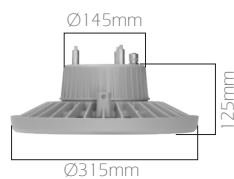

Code	D-OLS
LED	High efficient Mid-Power and COB Led
System Power	24 W
Colour Temperature	3000 - 4000 - 5000 K
Voltage	220V - 50Hz
Body	Aluminum injection
Diffuser	Opal
Cooler	Cooling from the body surface
Colour	Grey
Box Dimensions	40x20x40 cm
Weight	3.600 gr



Canopy Luminaires

PETROLED

IP66

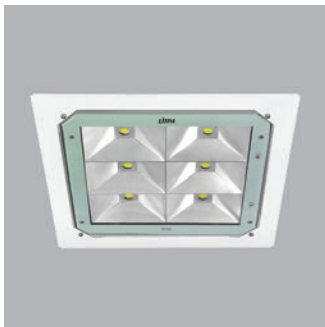

PTL/S



PTL/AS

PTL/ECO

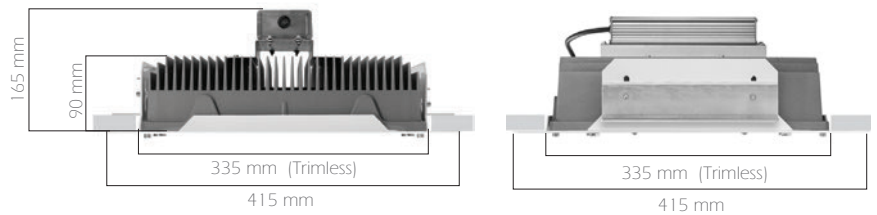

PETROLED Series fixtures produced as canopy fixtures and which can be used under fringes are robust fixtures and are resistant against exterior ambient conditions with durable die-cast aluminum body. The desired light distribution is ensured while maintaining high optical yield at the same time thanks to Miro-Silver reflectors made from material produced especially for LEDs by the German company named Alanod.

Fixtures can be produced symmetrical or asymmetrical according to requirement. Furthermore, economic series can also be produced.

PTL/S

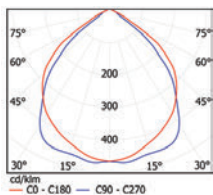

PTL/AS

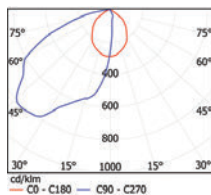

PTL/ECO

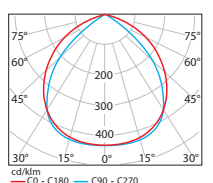

Code	PTL 40/S-AS PTL 60/S-AS PTL 100/S-AS	PTLECO 40/S-AS PTLECO 60/S-AS PTLECO 80/S-AS
LED	High Efficient COB LED	Multi-Power Led
System Power	35 W ~ 100 W	
Light Flux	4.000 lm - 9.500 lm	5.000-7.570-10.900lm
Colour Temperature	3000 - 4000 - 5000 K	
Voltage	220 Volt - 50 Hz	
Body	Aluminum injection	
Diffuser	Impact resistance tempered glass serigraphic printing	
Reflector	Alanod brand vacuum anodized Miro -Silver aluminum	
Cooler	Cooling from the Al. body surface	
Colour	White	
Accessory	Recessed ceiling apparatus	
Box Dimensions	43x43x17 cm	
Weight	11.100 gr	

INDOOR LIGHTING

LUMINAIRES





Downlight

SHOPLED

IP20

High energy-efficient SHOPLED downlight fixtures can be used in many areas with the large usage area thereof including shops, hotels, restaurants, cafés, educational areas hospital and houses. They can meet the investment in the usage area after a very short time even with the change of the existing systems. The lives of used COB LEDs are very long due to their fixture bodies and the aluminum coolers placed thereon.



SLG 104



SLG 160

SLG 165



SLG 195

SLG 200

SLG 104

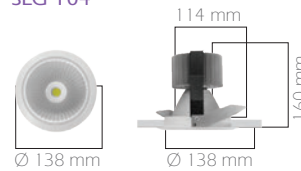

Ø 138 mm

SLG 160 - SLG 165

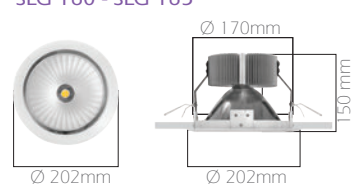

Ø 202mm

Ø 202mm

SLG 195 - SLG 200

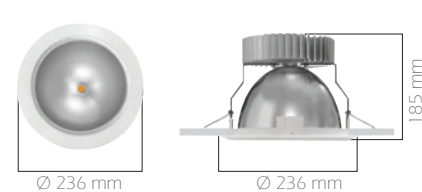

Ø 236 mm

Ø 236 mm

Code	Cut-Out
SLG 104	120 mm
SLG 160	171 mm
SLG 165	171 mm
SLG 195	205 mm
SLG 200	205 mm

SLG 104 Narrow

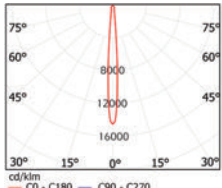

SLG 165

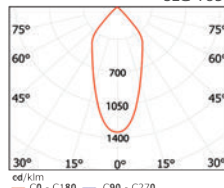

SLG 104 Wide

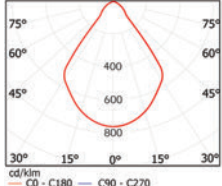

SLG 195

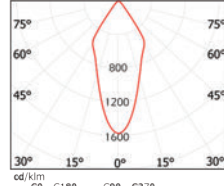

SLG 160

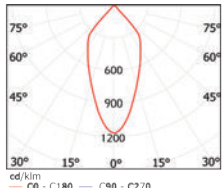

SLG 200

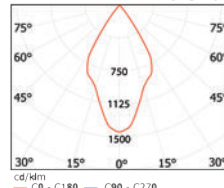

Code	SLG 104	SLG 160 SLG 165	SLG 195 SLG 200
LED	High Efficient COB LED		
LED Power	13 W	27 W	36 W
Light Flux	1,280 lm	2,560 lm 2,500 lm	3,200 lm 3,000 lm
Colour Temperature	3000 - 4000 - 5000 K		
Voltage	220V - 50Hz		
Body	Die-cast aluminum frame painted with 80 micron thick		
Reflector	99% pure aluminum		
Diffuser	Acrylic diffuser or tempered glass		
Cooler	Aluminum extrusion		
Colour	White		
Box Dimensions	30x44x21cm(6pcs)	47x47x18 cm(4pcs) 21x23x18 cm(1pcs)	25x26x24 cm(1pcs) 26x26x25 cm(1pcs)
Weight	4.400 gr(6pcs)	5.250gr(4pcs) 1.350gr(1pcs)	1.800 gr(1pcs) 1.650 gr(1pcs)



Downlight

FASHIONLED

IP20



FASHIONLED is type of fixture which can be easily used in a practical manner thanks to the design thereof allowing it to be moved and turned to all directions easily by mounting on rails in case of need for store, shop window and emphasized lighting. Multiple blades placed thereon transfers the cooling area from an extremely large surface to environment. Thus, highly efficient COB LEDs can have a very long life. Reflector options with 10°, 30° and 60° are available. A wide choice is offered to users with different strengths and body structures.

RLK 13



RLK 27



RLP 13

RLP 27

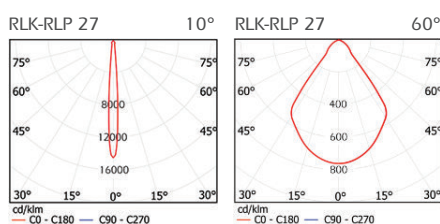
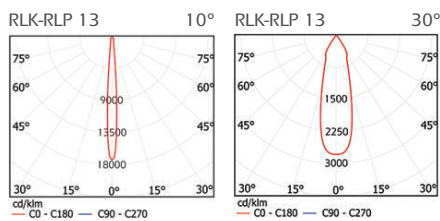
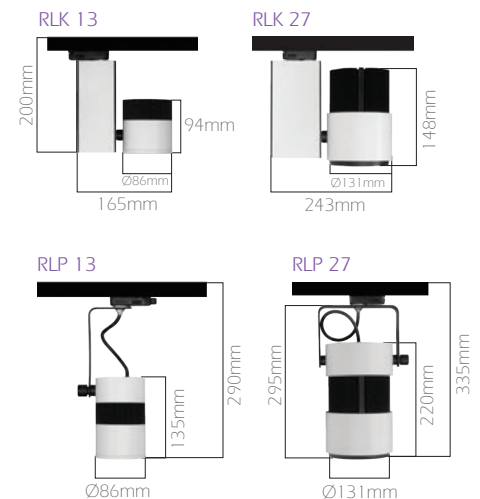

Code	RLK 13	RLP 13	RLK 27	RLP 27
LED	High Efficient COB LED			
LED Power	13 W		27 W	
Light Flux	1,350 lm		2.650 lm	
Colour Temperature	3000 - 4000 - 5000 K			
Voltage	220V - 50Hz			
Body	Aluminum extrusion and aluminum frame			
Reflector	99% pure aluminum			
Diffuser	3 mm thickness transparent tempered glass			
Cooler	Aluminum extrusion			
Colour	White			
Box Dimensions	22x17x29 cm		25x25x40 cm	
Weight	900 gr		2.700 gr	



DML 1



DML 2



DML 3



DML 4

Downlight

SHOWLED

IP20



SHOWLED is a highly efficient and economical type fixture with a wide range of applications used in interior. Spots in 2, 3 and 4-piece units are designed to move independently from each other. In this way, light from a single fixture can be transmitted simultaneously to different directions.

Mounting feet press firmly on the surface to prevent the gap between ceiling and the mounting frame and bad appearance due to assembly can be prevented. Different reflector structures offer possibilities to meet your requirements from the optical point of view. High LED efficiency and highly efficient reflectors thereof will provide significant energy savings for your business.

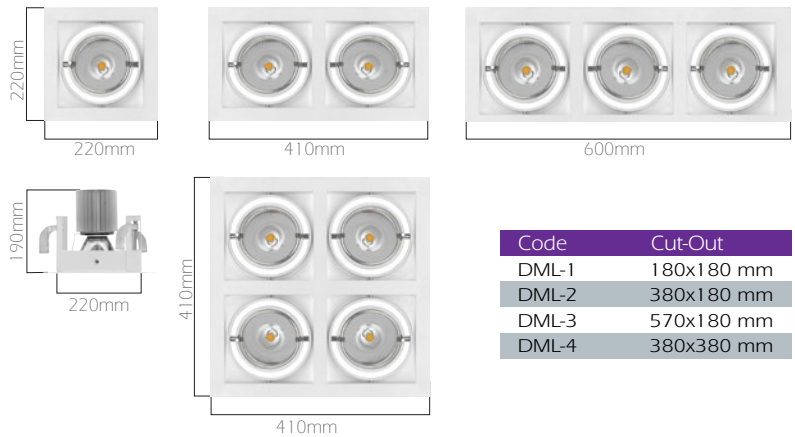

Code	DML 1	DML 2	DML 3	DML 4
LED	High Efficient COB LED			
LED Power	1x13 W 1x27 W 1x36 W	2x13 W 2x27 W 2x36 W	3x13 W 3x27 W 3x36 W	4x13 W 4x27 W 4x36 W
Light Flux	1,350 lm 2.650 lm 3.350 lm	2,700 lm 5.300 lm 6.700 lm	4.050 lm 7.950 lm 10.050 lm	5.400 lm 10.600 lm 13.400 lm
Colour Temperature	3000 - 4000 - 5000 K			
Voltage	220V - 50Hz			
Body	Made of 1 mm thick sheet steel and painted with powder paint			
Reflector	1 mm thick anodized aluminum vacuum 99.9 %			
Cooler	6063 T5 aluminum extrusion			
Colour	Grey			
Box Dimensions	24x24x21 cm	24x45x21 cm	24x64x21 cm	45x45x21 cm
Weight	2.100 gr	4.100 gr	6.200 gr	8.200 gr

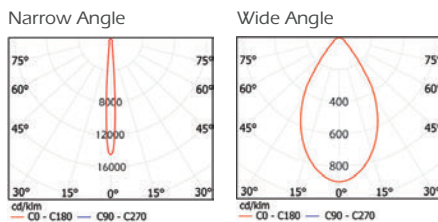



Downlight

GALAXYLED

IP20



DL 2003



DL 2004

DL 2005

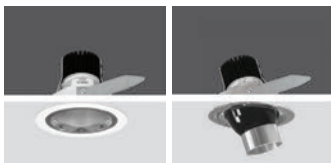

DL 2006

DL 2020

GALAXYLED fixtures are suitable for use in many areas such as particularly hotels, restaurants, plazas, shopping malls and stores. COB LEDs furnish extremely good fixture efficiency and stable operation by virtue of high-efficient reflectors and coolers manufactured from aluminum material with high-grade heat transfer. They lower the amount of visual pollution to minimum levels and help you to achieve the desired lighting levels. They are suitable for effects and decorative lighting with different optical and power options.

DL 2003-2004-2005-2006

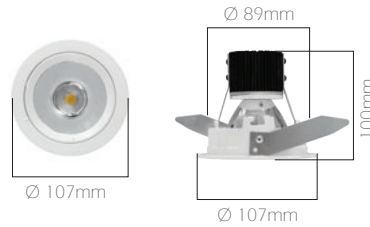

DL 2020

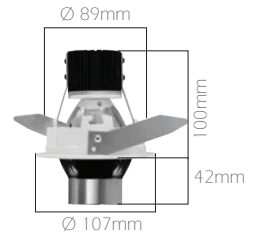

Code	Cut-Out
DL-2003	Ø 93 mm
DL-2004	Ø 93 mm
DL-2005	Ø 93 mm
DL-2006	Ø 93 mm
DL-2020	Ø 93 mm

DL 2003-C1

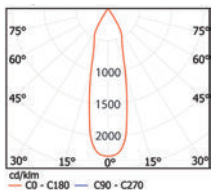

DL 2003-C2

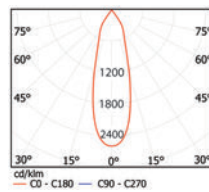

DL 2004

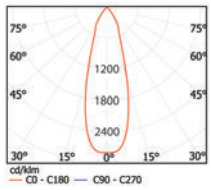

DL 2005

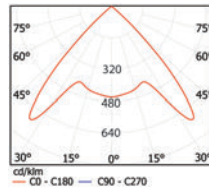

DL 2006

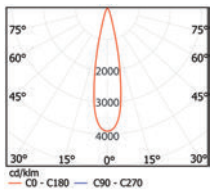

DL 2020

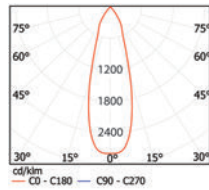

Code	DL 2003 C1 DL 2003 C2	DL 2004	DL 2005	DL 2006	DL 2020
LED	High Efficient COB LED				
System Power	5.5 W				
Light Flux	462 lm 438 lm	426 lm	465 lm	516 lm	90 lm
Colour Temperature	3000 - 4000 - 5000 K				
Cooler	Aluminum extrusion				
Voltage	220V - 50Hz				
Body	Aluminum injection frame				
Reflector	High pure aluminum				
Diffuser	65 mm diameter 3 mm thick transparent tempered glass				
Colour	Grey				
Box Dimensions	15x15x12.5 cm				15x15x13cm
Weight	490 gr	500 gr	550 gr	480 gr	600 gr



Downlight

SFR

IP20

SFR model downlight fixtures are indispensable application elements for interior lighting with their compact and simple structure. They can be applied in hotels, schools, shopping centers and many other places. Reflectors used in the fixture to perform this task without requiring extra frame and provide an appearance integrated with the ceiling and which does not harm the aesthetics structure of the area thanks to the fine structure thereof. They offer a perfect solution in locations where dark light is desired and glare is unwanted by using black reflector.



SFR 13/S White



SFR 13/S Black SFR 13/L



SFR 5 Black SFR 5 White



SFR 8

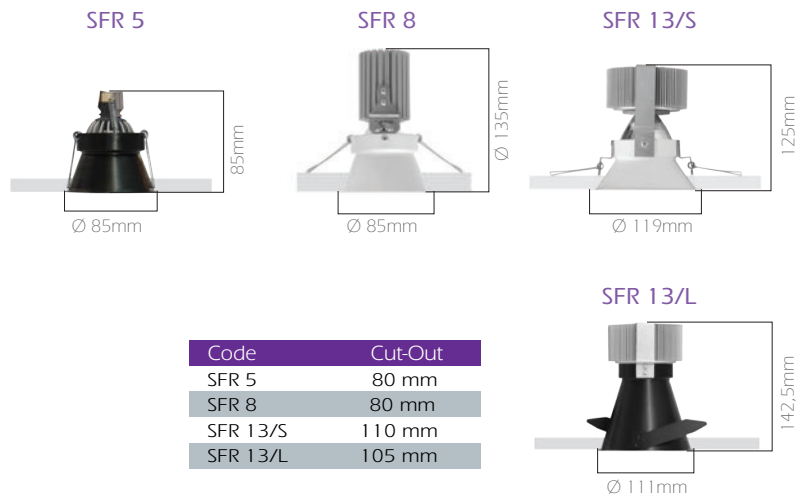

Code	Cut-Out
SFR 5	80 mm
SFR 8	80 mm
SFR 13/S	110 mm
SFR 13/L	105 mm

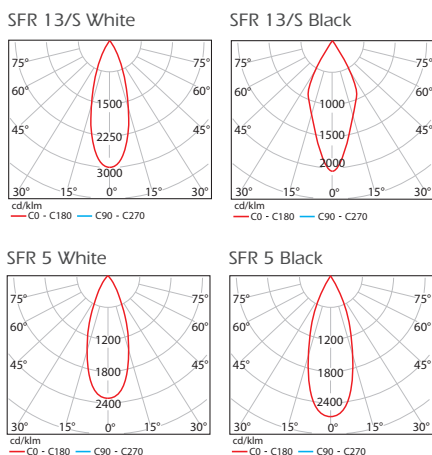

Code	SFR 5	SFR 8	SFR 13/S	SFR 13/L
LED	PAR16 LED	High Efficient COB LED		
LED Power	5.5 W	8 W	13 W	13 W
Light Flux	403lm-Black Ref. 431lm-White Ref.	660lm-White Ref. -	708lm Black Ref. 833lm-White Ref.	833lm-White Ref. -
Colour Temperature	3000 - 4000 - 5000 K			
Voltage	220V - 50Hz			
Body	Manufactured from spinning aluminum and painted with 80 mm electrostatic powder paint			
Reflector	Spining aluminum			
Cooler	Aluminum extrusion			
Colour (Reflector)	White or Black			
Box Dimensions	10,5x10,5x10,5cm	10,5x10,5x15cm	14x13x13cm	16x13x13cm
Weight	250 gr	350 gr	450 gr	450 gr



Downlight

SLA

IP20



SLA series with its hoop structure designed provides a perfect match with the ceiling and it appears to be a part of the ceiling in the areas applied thanks to its oval structure. Due to this, it gives the effect as if light came from the inside of the ceiling while the products are on. Not only is the general lightning homogeneous, but also it forms a nice effect on the ceiling.

SLA 165

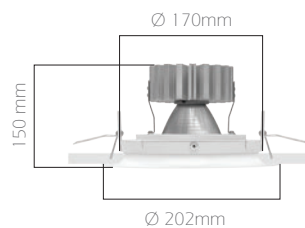

SLA 195

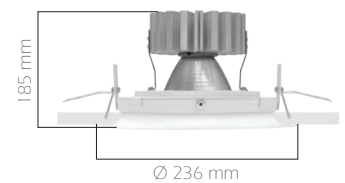

Code	SLA 165	SLA 195
LED	High Efficient COB LED	
LED Power	27 W	36 W
Light Flux	2.650 lm	3.350 lm
Colour Temperature	3000 - 4000 - 5000 K	
Voltage	220V - 50Hz	
Body	Die-cast aluminum frame painted with 80 micron thick	
Cooler	Aluminum extrusion	
Glass	3mm tempered glass	
Colour	White, grey and black	
Box Dimensions	21x23x18 cm(1 pcs)	25x26x24 cm(1 pcs)
Weight	1.350gr(1 pcs)	1.800 gr(1 pcs)



Downlight

PUNTO

IP20

High permeability opal diffuser transfers light to the environment in soft a way. High lighting efficiency and a clear appearance is achieved thanks to Furukawa reflectors used in the inner side surface of the fixture. Affordability, efficiency and slimness are three words that summarize Punto Series downlights best.



SSL 104



SSL 160

SSL 200



SSL 235

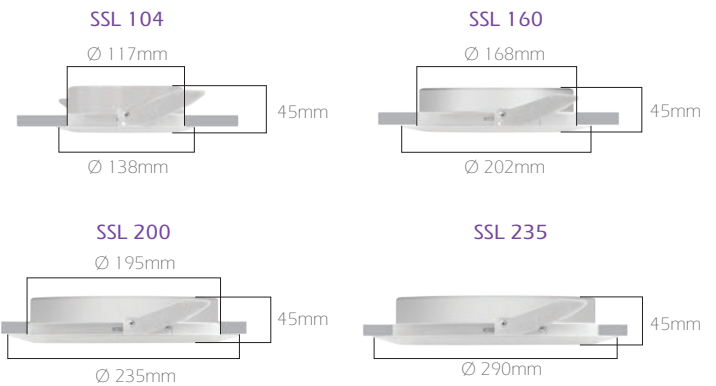

Code	Cut-Out
SSL 104	120 mm
SSL 160	171 mm
SSL 200	205 mm
SSL 235	245 mm

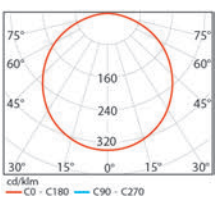

Code	SSL 104	SSL 160	SSL 200	SSL 235
LED	High efficient Mid-Power LED			
LED Power	7 W 10 W 16 W	14 W 20 W 26 W	17 W 24 W	17 W 24 W 32 W
Light Flux	870 lm 1,190 lm 1,250 lm	1,240 lm 1,730 lm 1,940 lm	1,800 lm 2,530 lm	1,800 lm 2,530 lm 3,300 lm
Colour Temperature	3000 - 4000 - 5000 K			
Voltage	220V - 50Hz			
Body	Aluminum injection frame.			
Diffuser	Opal			
Cooler	Cooling from the body surface			
Colour	White			
Box Dimensions	15x15x7cm	22x22x7cm	25x25x7cm	30x30x7cm
Weight	250 gr	450 gr	450 gr	550 gr



Downlight

PNS

IP20



Highly energy-efficient PNS model surface-mounted fixtures came under the category downlight fixtures. Opal diffuser transfers light to the environment uniformly and thus this fixture can be used in a wide range of applications. The circular form of the fixture provides ease of installation and therefore the fixture can be easily installed in areas. The fixtures are designed with the purpose of high efficiency lighting over a very long period of time. In addition, they are produced with the high-quality materials.

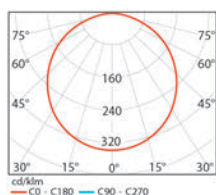
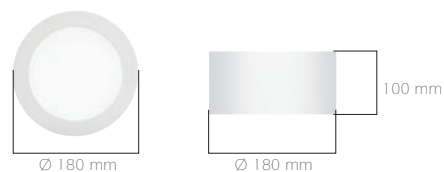

Code	PNS
LED	High efficient Mid-Power LED
System Power	13 W
Light Flux	1.000 lm
Colour Temperature	3000 - 4000 - 5000 K
Voltage	220V - 50Hz
Body	Spinned aluminum
Frame	Aluminum injection
Diffuser	Opal
Colour	White
Optional	1 hour kits

HRN

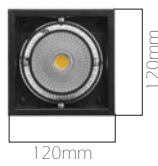
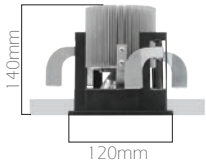
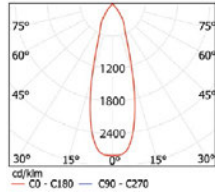

IP20

Code	HRN
LED	High Efficient COB LED
LED Power	13,5 W - 27 W
Light Flux	1.134 lm - 2.268 lm
Colour Temperature	3000 - 4000 - 5000 K
Voltage	220V - 50Hz
Body	0,6 mm thick sheet
Reflector	99.9 % purity aluminum
Cooler	6063 T5 aluminum extrusions
Colour	White, Black

GORDON

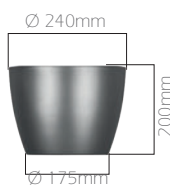
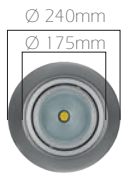

IP20

Code	MSD
LED	High Efficient COB LED
System Power	13 W
Light Flux	1.350 lm
Colour Temperature	3000 - 4000 - 5000 K
Voltage	220AC - 50Hz
Body	1,5 mm aluminum. 80 micron epoxy polyester paint. Surface mounted or pendant.
Reflector	Manufactured from 1 mm thick high pure (99,9%) aluminum
Glass	Tempered glass with silicon gasket
Box Dimensions	24x24x20 cm
Weight	1.650 gr

LKG

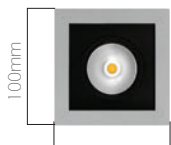
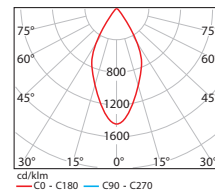
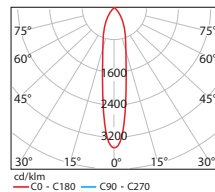

IP20

Code	LKG 5	LKG 8
LED	High Efficient COB LED	
System Power	5.5 W	8 W
Light Flux	481 lm	660 lm
Colour Temperature	3000 - 4000 - 5000 K	
Voltage	220V - 50Hz	
Body	1 mm thick DKP sheet and 80 micron thick electrostatic powder paint	
Reflector	High efficient aluminum	
Cooler	Aluminum extrusion	
Frame	1,5 mm thickness DKP sheet steel, inner frame aluminum injection	
Box Dimensions	30x44x15 cm (6pcs)	
Weight	3.200 gr (6pcs)	
Cut-Out	93X93 mm	

PGH

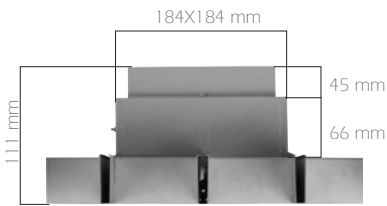

IP20

Code	PGH
LED	High Efficient Mid-Power LED
System Power	10 W - 15 W - 20 W
Light Flux	840 lm - 1.170 lm - 1.580 lm
Colour Temperature	3000 - 4000 - 5000 K
Voltage	220V - 50Hz
Body	0.6mm made DKP steel sheet and painted with 80 micron thickness.
Reflector	0.4 mm thick pure aluminum
Diffuser	High permeability material in Opal
Cooler	Cooling from the body surface
Colour	Grey
Box Dimensions	220x220x175 mm

PLG

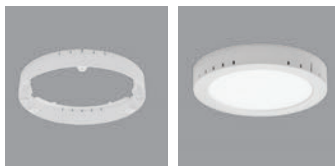
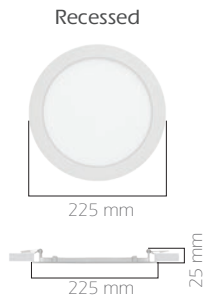

Surface mounted apparatus Surface mounted type

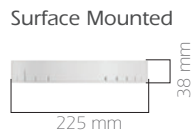

IP20

Code	PLG
LED	High Efficient Mid-Power LED
System Power	18 W
Light Flux	1.375 lm
Colour Temperature	3000 - 4000 K
Voltage	220V - 50Hz
Body	ABS
Diffuser	Opal
Box Dimensions	23x28x3 cm
Weight	375 gr
Cut-Out	Φ210mm

ELD 75

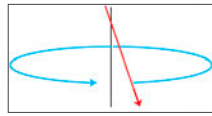

Rotatable

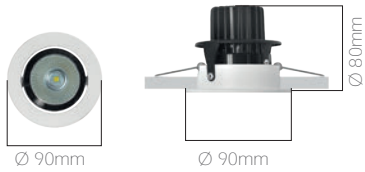

IP20

Code	ELD 75/5	ELD 75/8
LED	High Efficiency Power LED	
System Power	5 W	8 W
Light Flux	480 lm	660 lm
Colour Temperature	3000 - 4000 - 5000 K	
Voltage	220V - 50Hz	
Body	Aluminum injection	
Cooler	Aluminum	
Reflector	Aluminum	
Glass	3mm thick transparent tempered	
Box Dimensions	12x12x12 cm	
Weight	290 gr	
Cut-Out	Ø 75 mm	

ELD 125

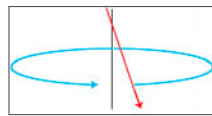
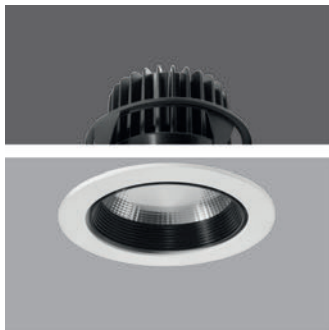

Rotatable

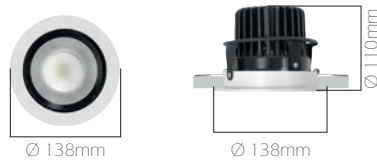

IP20

Code	ELD 125
LED	High Efficiency Power LED
System Power	13 W
Light Flux	1,350 lm
Colour Temperature	3000 - 4000 - 5000 K
Voltage	220V - 50Hz
Body	Aluminum injection
Cooler	Aluminum
Reflector	Aluminum
Glass	3mm thick transparent tempered
Box Dimensions	15x15x15 cm
Weight	740 gr
Cut-Out	Ø 125 mm

ML 110

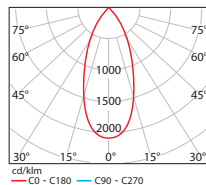

IP20

Code	ML 110
LED	High Efficient COB LED
System Power	5 - 13, 27 W (active cooling)
Light Flux	481 - 1456 - 2762 lm
Colour Temperature	3000 - 4000 - 5000 K
Voltage	220V - 50Hz
Body	Aluminum injection
Reflector	Aluminum
Cooler	5-13W (passive), 27W (active cooling)
Diffuser	Tempered glass, transparent
Box Dimensions	16x16x15 cm
Weight	850 gr
Cut-Out	Ø 110 mm

L1671

IP20 - IP54

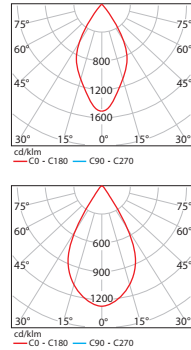

Code	L1671/5	L1671/8
LED	High Efficiency Multi-Power, COB LED	
System Power	5.5 W	8 W
Light Flux	481 lm	660 lm
Colour Temperature	3000 - 4000 - 5000 K	
Voltage	220V - 50Hz	
Body	Aluminum injection	
Reflector	99% pure aluminum	
Cooler	Aluminum extrusion	
Glass	3mm thick, transparent, tempered	
Box Dimensions	30x44x15 cm (6pcs)	
Weight	2.300 gr (6pcs)	
Cut-Out	Ø 68 mm	

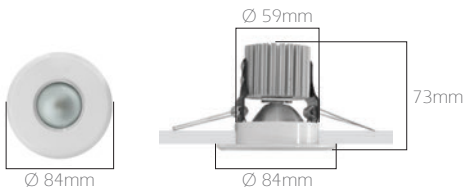

L1672

IP20



L1672/S



L1672/AS

Code	L1672/S	L1672/AS
LED	Led Lamp	
System Power	5.5 W	
Light Flux	350 lm	
Colour Temperature	4000 K	
Voltage	220V - 50Hz	
Body	0,80 mm sheet steel	
Colour	White	
Box Dimensions	13,5x12x13,5 cm	
Weight	0,35 kg	
Cut-Out	Ø 86 mm	



Office Lighting

OFISLED

IP20

LGS has been developed to transfer high LED technology to office lighting. Production is possible for all types of suspended ceilings. Therefore, production is made according to the brand/model of the suspended ceilings to be used. Glare and screen reflections have been taken into consideration in the optical design of the fixture which are the most important requirements in offices and Cat-1 Cat-2 types of the fixture have been developed. OFISLED is a lighting system which meets its investments by the savings it provides by renewal of existing systems thanks to high effectiveness of the LEDs and fixture efficiency compared to conventional fluorescents and T5 fixtures.



LGS 60-60/3



LGS 60-60/4

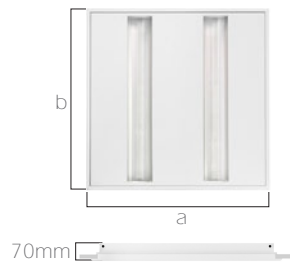

	Code	a	b	Cut-Out
Plaster Ceiling	LGS 001 30-60	295mm	595mm	280x580mm
	LGS 001 60-60	595mm	595mm	580x580mm
	LGS 001 30-120	295mm	1195mm	280x1180mm
Clip-in	LGS 002 30-60	299mm	599mm	-
	LGS 002 60-60	599mm	599mm	-
Modular	LGS 002 30-120	299mm	1199mm	-
	LGS 300 30-60	295mm	595mm	-
	LGS 300 60-60	595mm	595mm	-
	LGS 300 30-120	295mm	1195mm	-

Code	LGS 60-60/3	LGS 60-60/4	LGS 30-120/1
LED	High efficient Mid-Power LED		
System Power	27 W	35 W	52 W
Light Flux	3,150 lm	4,200 lm	6,300 lm
Colour Temperature	3000 - 4000 - 5000 K		
Driver	Osram or Tridonic		
Voltage	220V - 50Hz		
Body	0,6 mm A1 quality DKP sheet steel 80 micron powder paint		
Optic	Cat-1,Cat-2	Cat-1,Cat-2	Cat-1,Cat-2
Reflector (inner)	Alanod Miro-Silver 27 AG aluminum		
Reflector (outer)	(Cat1) Alanod Miro Silver27/4270 AG aluminum (Cat2) Alanod Miro-Silver 20/2000 AG aluminum		
Diffuser	2,8 mm microprismatic lens		
Cooler	Cooling from the body surface		
Colour	White		
Box Dimensions	67x61x9cm	30x122x9cm	
Weight	5.000 gr	5.500 gr	

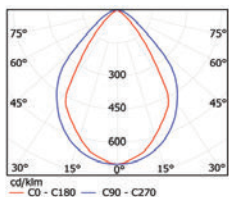

Office Lighting

OFISLED

IP20



LGO

This is a fixture model with a wide usage and application. The light coming from multiple LED sources in LGO fixtures passes through the opal diffuser of and provides an extremely soft and homogeneous distribution to the environment. Production for all types of suspended ceilings is possible. Therefore, production is made according to the brand/model of the suspended ceiling to be used. This fixture, like all Litpa fixtures is highly efficient and economical.

		Code	a	b	Cut-Out
Gypsum	LGO 001 30-60	295mm	595mm	280x580mm	
	LGO 001 60-60	595mm	595mm	580x580mm	
	LGO 001 30-120	295mm	1195mm	280x1180mm	
Clip-in	LGO 002 30-60	299mm	599mm	-	
	LGO 002 60-60	599mm	599mm	-	
	LGO 002 30-120	299mm	1199mm	-	
Modular	LGO 300 30-60	295mm	595mm	-	
	LGO 300 60-60	595mm	595mm	-	
	LGO 300 30-120	295mm	1195mm	-	

70 mm

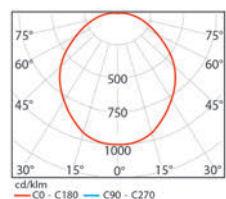

Code	LGO 60/27	LGO 60/35
LED	High efficient Mid-Power LED	
System Power	27 W	35 W
Light Flux	2,607 lm	3,575 lm
Colour Temperature	3000 - 4000 - 5000 K	
Voltage	220V - 50Hz	
Body	0,6mm thick A1 quality DKP sheet steel. 80 micron electrostatic powder coated	
Diffuser	2,8 mm Opal	
Cooler	Cooling from the body surface	
Colour	White	
Box Dimensions	65x64x14 cm	
Weight	5.100 gr	

Office Lighting

LEG-PR / LEG-OP

IP20

Glare and screen reflections have been taken into consideration in the optical design of the LEG series fixtures which are direct-indirect fixtures which are the most important requirements in offices. The fixture has been developed in direct - indirect mixed optical structure according to Cat-1 and Cat-2 types. The fixture is produced in different optical structures as double parabolic and opal. It is designed to be used in a suitable way in any office perfectly.



LEG-PR



LEG-OP

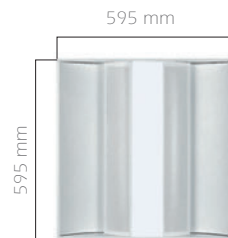

	Code	a	b	Cut-Out
Recess Ceiling	LEG-PR 001	595mm	595mm	580x580mm
	LEG-OP 001	595mm	595mm	580x580mm
Clip-in	LEG-PR 002	599mm	599mm	-
	LEG-OP 002	599mm	599mm	-
Modular	LEG-PR 300	595mm	595mm	-
	LEG-OP 300	595mm	595mm	-

Code	LEG-PR	LEG-OP
LED	High efficient Mid-Power LED	
System Power	25 - 35 W	25 - 35 W
Light Flux	2350 lm	2300 lm
Colour Temperature	3000 - 4000 - 5000 K	
Driver	Osram or Tridonic	
Voltage	220V - 50Hz	
Body	6114, A1 quality DKP sheet steel	
Reflector	0,4 mm thickness aluminum	
Cooler	Cooling from the body surface	
Colour	White	
Box Dimensions	61x67x9 cm	61x67x9 cm
Weight	4.900 gr	5.100 gr

Office Lighting

MOON

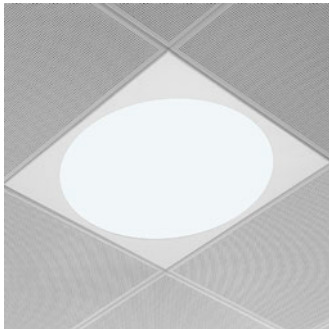

IP20

OLG Series fixtures offer your esteemed side an option with rounded and stylish forms with high efficiency. They can be used single while they provide a distinctive ambiance to the spaces they are used when using side by side and in multi usage.

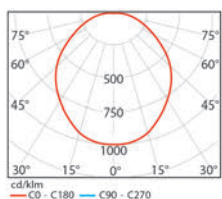
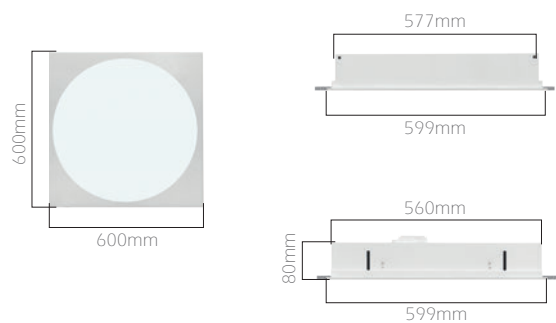

Code	OLG 60/27	OLG 60/35
LED	High efficient Mid-Power LED	
System Power	27 W	35 W
Light Flux	2,607 lm	3,575 lm
Colour Temperature	3000 - 4000 - 5000 K	
Voltage	220V - 50Hz	
Body	0,6 mm thick A1 quality DKP sheet steel. 80 micron electrostatic powder paint.	
Cooler	Cooling from the body surface	
Diffuser	Opal	
Colour	White	
Box Dimensions	62x62x10 cm	
Weight	5.200 gr	



Office Lighting

FNSB-K

IP20



FNSB-K series designed in the form of square to be driven into the ceiling allows soft lighting applications and the LED technology used ensures energy-saving substantially. Ensures practical solutions thanks to its compliance with different types of suspended ceilings as well as different power ranges.

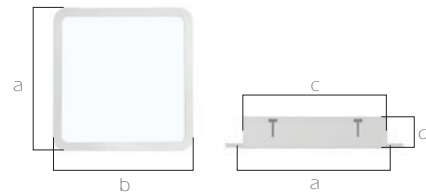

Code	a	b	c	d	Cut-Out
FNSB-K 20	200 mm	200 mm	169 mm	82 mm	175X175 mm
FNSB-K 40	400 mm	400 mm	369 mm	82 mm	375X375 mm

Code	FNSB-K 20	FNSB-K 40
LED	High efficient Mid-Power LED	
System Power	10W - 20W	20W - 30W
Light Flux	960 lm - 1,790 lm	1,990 lm - 2,680 lm
Colour Temperature	3000 - 4000 - 5000 K	
Voltage	220V - 50Hz	
Body	0.6 mm thick DKP sheet steel	
Reflector	0.3 mm thick aluminum	
Diffuser	Opal	
Cooler	Cooling from the body surface	
Frame	1.5 mm thick DKP sheet steel	
Colour	White	
Box Dimensions	22x22x10 cm	42x42x10 cm
Weight	2.000 gr	3.000 gr

Office Lighting

FNSB-Y

IP20



FNSB-Y series designed in the form of circle to be driven into the ceiling allows soft and diffuse lighting applications and the LED technology used ensures energy-saving substantially. Ensures practical solutions thanks to its compliance with different types of suspended ceilings as well as different power ranges.

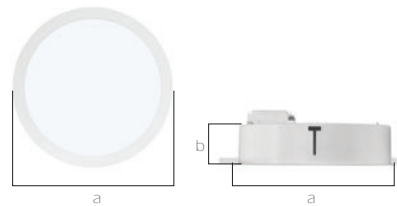

Code	a	b	Cut-Out
FNSB-Y 25	250 mm	82 mm	Ø 237 mm
FNSB-Y 35	350 mm	82 mm	Ø 327 mm
FNSB-Y 55	550 mm	82 mm	Ø 527 mm

Code	FNSB-Y 25	FNSB-Y 35	FNSB-Y 55
LED	High efficient Mid-Power LED		
System Power	17 W - 24 W	22 W - 30 W	40 W
Light Flux	1,800 lm - 2,530 lm	2,320 lm - 3,160 lm	3,580 lm
Colour Temperature	3000 - 4000 - 5000 K		
Voltage	220V - 50Hz		
Body	0.8 mm thick DKP sheet steel		
Diffuser	Opal		
Cooler	Cooling from the body surface		
Frame	1.5 mm thick DKP sheet steel		
Colour	White		
Box Dimensions	27x27x10 cm	37x37x10 cm	57x57x10 cm
Weight	1.950 gr	3.100 gr	6.550 gr



Office Lighting

LSS

IP20

LSS luminaires, which are a surface mounted model of luminaire, are presented as a complete solution in the places such as offices and etc. in order to remove the problems of glare. It increases the productivity to the top level for the employees by increasing light quality in the work environment. They are produced with 2, 3 and four-lamelle according to the amount of the light requested. Thanks to high quality materials used, extremely high performance and savings are provided.



LSS 60-60/4



LSS 60-60/3

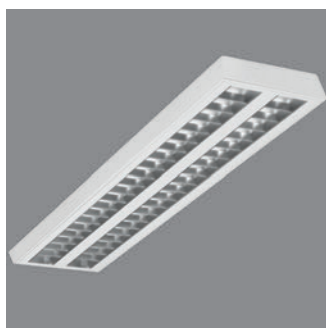

LSS 30-120/2
Double parabolic reflector (optional)

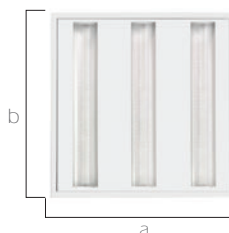

72 mm

Code	a	b
LSS 60-60/4	600mm	600mm
LSS 60-60/3	600mm	600mm
LSS 30-30/2	300mm	300mm
LSS 30-120/2	300mm	1200mm

Code	LSS 60-60/4	LSS 60-60/3	LSS 30-30/2	LSS 30-120/2
LED	High efficient Mid-Power LED			
System Power	35 W	27 W	18 W	27 W
Light Flux	4,200 lm	3,150 lm	2,350 lm	3,150 lm
Colour Temperature	3000 - 4000 - 5000 K			
Driver	Osram or Tridonic			
Voltage	220V - 50Hz			
Body	0,6 mm A1 quality DKP sheet steel 80 micron powder paint			
Optic	Cat-1,Cat-2	Cat-1,Cat-2	Cat-1,Cat-2	Cat-1,Cat-2
Reflector (inner)	Alanod Miro-Silver 27 AG aluminum			
Reflector (outer)	(Cat1) Alanod Miro Silver27/4270 AG aluminum (Cat2) Alanod Miro-Silver 20/2000 AG aluminum			
Diffuser	2,8 mm microprismatic lens			
Cooler	Cooling from the body surface			
Colour	White			
Box Dimensions	67x61x9cm	67x61x9cm	37x31x9cm	127x31x9cm
Weight	5.700 gr	5.500 gr	2.800 gr	5.800 gr

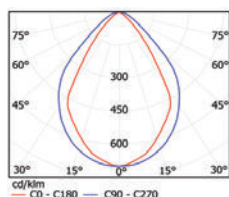

Office Lighting

LSO

IP20

LSO luminaires, which have a lot of usage areas, are used in the places where there are no opportunities of recessed ceiling by installing onto the surface. They are produced with the shape square and rectangle according to the needs and meets different needs of power. They are produced with the understanding of eye-pleasing simple, stylish structure and high quality production.



LSO 60-60



LSO 30-120

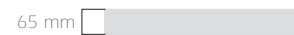
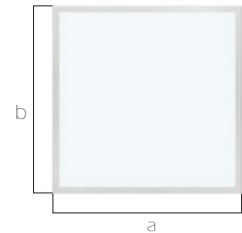

Code	a	b
LSO 30-30	300 mm	300 mm
LSO 60-60	600 mm	600 mm
LSO 30-120	1200 mm	300 mm

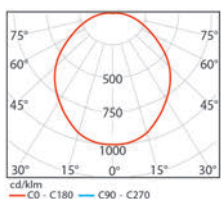

Code	LSO 30-30	LSO 30-120	LSO 60-60
LED	High efficient Mid-Power LED		
System Power	20 W	30 W	35 W
Light Flux	2.350 lm	3.160 lm	3.575 lm
Colour Temperature	3000 - 4000 - 5000 K		
Voltage	220V - 50Hz		
Body	0,60 DKP sheet		
Diffuser	2,8 mm thick opal		
Cooler	Cooling from the body surface		
Frame	4 mm DKP sheet		
Colour	White or Grey		
Box Dimensions	32 X32 X 8 cm	32 X122 X 8 cm	65x64x14 cm
Weight	2.000 gr	5.000 gr	5.100 gr

Office Lighting

LSL-P / LSL-OP

IP20

LSL Series fixtures are surface-mounted fixture with a wide high range of applications. The fixture is produced in different optical structures as double parabolic and opal. The high permeable lens material prevents the decrease of fixture efficiency while eliminating the problem of glare. It enables economic use by mounting to ceiling easily and thanks to the low energy consumption thereof.



LSL-P



LSL-OP

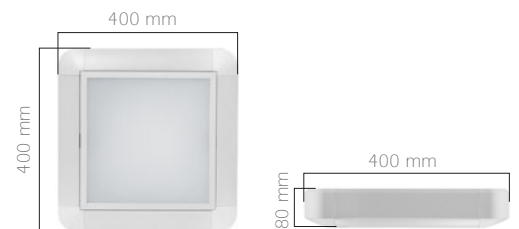

Code	LSL-P	LSL-OP
LED	High efficient Mid-Power LED	High efficient Mid-Power LED
System Power	18 W	14,5 W
Light Flux	2350 lm	1500 lm
Colour Temperature	3000 - 4000 - 5000 K	
Voltage	220V - 50Hz	
Body	A1 quality DKP sheet steel	
Reflector	Alanod Miro Silver 27/4270 AG	
Diffuser	3mm Micro-Prismatic 92% transparent	2.8 mm opal
Cooler	Cooling from the body surface	
Colour	White	
Box Dimensions	42x42x9cm	
Weight	2.800 gr	2.500 gr

Office Lighting

FNSS-Y

IP20



FNSS-Y 60

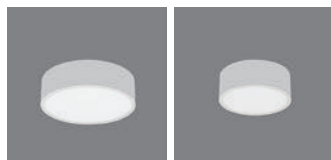

FNSS-Y 40

FNSS-Y 30

FNSS-Y model is a surface-mounted fixture in the form of circle with a stylish look and energy-saving is ensured substantially by virtue of the LED technology used and can be manufactured in various sizes.

FNSS-Y 60

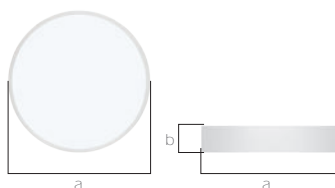

FNSS-Y 40

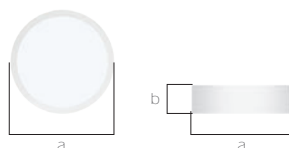

FNSS-Y 30

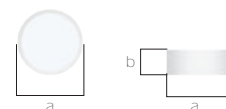

Code	a	b
FNSS-Y 30	260 mm	100 mm
FNSS-Y 40	350 mm	100 mm
FNSS-Y 60	550 mm	100 mm

Code	FNSS-Y 30	FNSS-Y 40	FNSS-Y 60
LED	High efficient Mid-Power LED		
System Power	17 / 24 W	20 / 30 W	40 W
Light Flux	1800/2530 lm	2320/3160 lm	3580 lm
Colour Temperature	3000 - 4000 - 5000 K		
Voltage	220 VAC - 50 Hz		
Body	1 mm thick aluminum		
Diffuser	1,5 mm thick opal		
Cooler	Cooling from the body surface		
Frame	Aluminum injection frame		
Colour	White		
Box Dimensions	28x28x15 cm	36x36x12 cm	67x61x10 cm
Weight	1.950 gr	3.100 gr	6.550 gr

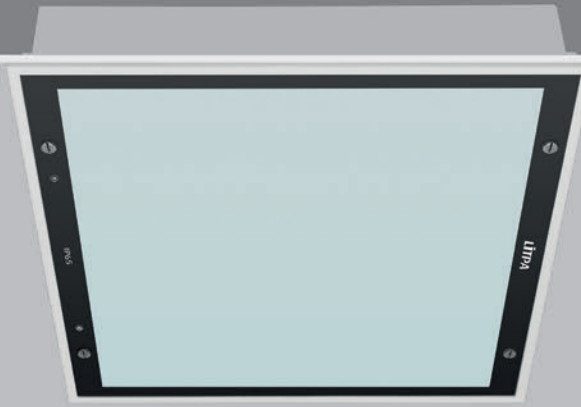

Antibacterial Lighting

HFC

IP65



HFC

Fixtures with high protection class are produced with specifications to be used in areas where hygiene is important.

Light coming from multi LED source in fixtures passes through a sandblasted specially produced glass, and provides an extremely soft and homogeneous distribution to the environment. Fixture efficiency is brought to the forefront in the clear glass option. It is possible to produce according to all types of suspended ceilings.



	Code	a	b	Cut-Out
Modular	HFC 300	595mm	595mm	580x580mm
Clip-in	HFC 002	599mm	599mm	-

Code	HFC
LED	High efficient Mid-Power LED
System Power	40 W
Light Flux	3,750 lm
Colour Temperature	3000-4000-5000 K
Cooler	Cooling from the body surface
Voltage	220V - 50Hz
Body	1 mm thick A1 quality DKP steel sheet. 80 micron electrostatic powder painted.
Glass	Tempered glass or opal
Colour	White
Box Dimensions	62x62x13cm
Weight	9.000 gr

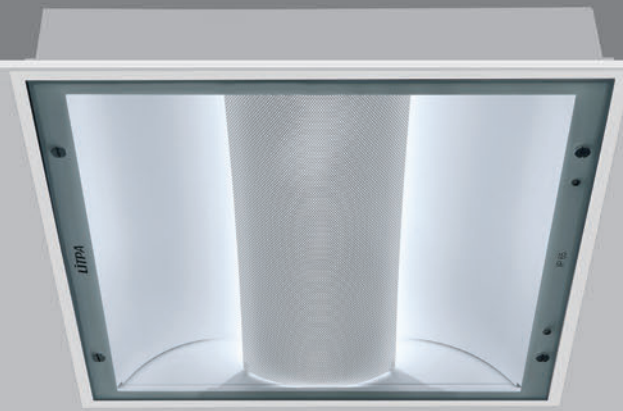

Antibacterial Lighting

HFC-SR

IP65



It is presented as a unique solution for hospitals, dentists and laboratories, where the provision of clean room conditions is obligatory in addition to its light distribution prevent glare. Liquid and dust particles that can penetrate into the fixture are prevented by fulfilling the requirements of high protection classes.

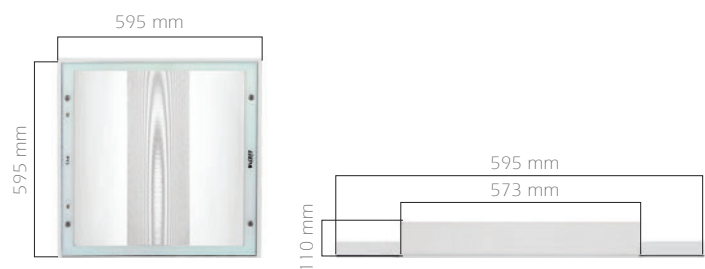

	Code	a	b	Cut-Out
Moduler	HFC 300/SR	595mm	595mm	580x580mm
Clip-in	HFC 002/SR	599mm	599mm	-

Code	HFC-SR
LED	High efficient Mid-Power LED
System Power	27W - 35W
Colour Temperature	3000-4000-5000 K
Cooler	Cooling from the body surface
Voltage	220V - 50Hz
Body	0,6mm thick A1 quality DKP sheet steel. Painted with 80 micron thick electrostatic paint.
Glass	Tempered and transparent glass
Reflector	0,4 mm thick aluminum
Colour	White
Box Dimensions	62x62x13cm
Weight	8.000 gr

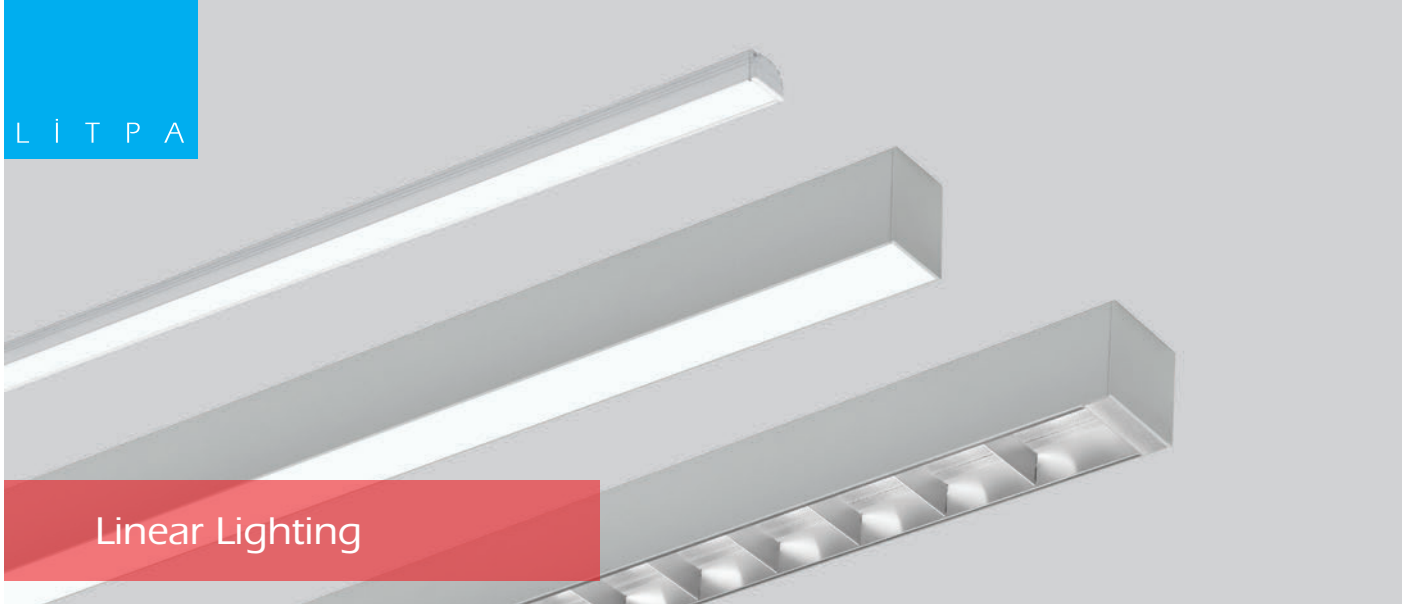

DFR / DFR Carisma

IP20

DFR fixtures which can be used as surface mounted and pendant are produced in 19 - 60 - 80mm width. They can be used as a single profile up to approximately 2.5 meters length in linear applications. They can be attached end to end and be used as a continuous light source. Height of the pendant can be easily adjusted thanks to spring mounting parts.



DFR 20

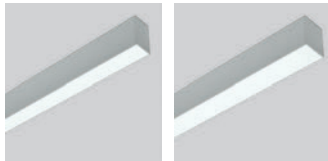

DFR 60

DFR 80

CARISMA

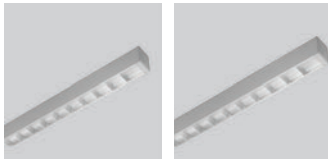

DFR 60/C

DFR 80/C



Code	a	b	c
DFR 20/100	1024mm	19mm	16mm
DFR 20/120	1194mm	19mm	16mm
DFR 20/150	1528mm	19mm	16mm
DFR 60/100	1024mm	60mm	85mm
DFR 60/120	1194mm	60mm	85mm
DFR 60/150	1528mm	60mm	85mm
DFR 80/100	1024mm	80mm	85mm
DFR 80/120	1194mm	80mm	85mm
DFR 80/150	1528mm	80mm	85mm

DFR 60/C and DFR 80/C luminaire dimensions are the same as the DFR 60 and DFR 80.

Code	DFR 20/100 DFR 20/120 DFR 20/150	DFR 60/100 DFR 60/120 DFR 60/150	DFR 80/100 DFR 80/120 DFR 80/150	DFR 60/C 100 DFR 60/C 120 DFR 60/C 150	DFR 80/C 100 DFR 80/C 120 DFR 80/C 150
LED	High efficient Mid-Power LED				
System Power	15 W 18 W 27 W	30 W 36 W 45 W	30 W 36 W 45 W	30 W 36 W 45 W	30 W 36 W 45 W
Light Flux	1,400 lm/m 1,680 lm/m 2,100 lm/m	2,800 lm/m 3,360 lm/m 4,200 lm/m	2,800 lm/m 3,360 lm/m 4,200 lm/m	2,800 lm/m 3,360 lm/m 4,200 lm/m	2,800 lm/m 3,360 lm/m 4,200 lm/m
Colour Temperature	3000 - 4000 - 5000 K				
Voltage	220V - 50Hz				
Body	Aluminum extrusion body and painted with electrostatic powder paint.				
Diffuser	2,8 mm thick prismatic lens				
Colour	White or Grey				
Weight	500 gr 600 gr 750 gr	3000 gr 3750 gr 4500 gr	3400 gr 4100 gr 5200 gr	3000 gr 3750 gr 4500 gr	3400 gr 4100 gr 5200 gr

DFR 60 - 80

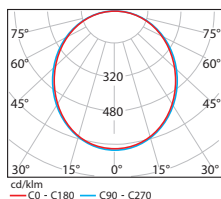

Linear Lighting

DFG

IP20

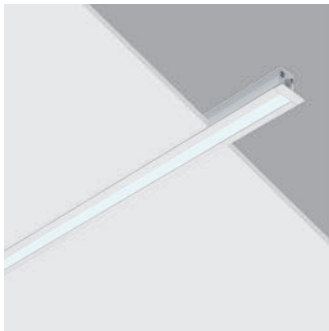

DFG 20

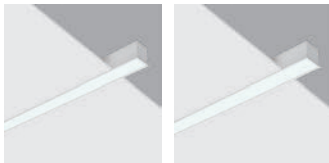

DFG 60

DFG 80

DFG fixture series, which are the recessed type of EOSLED are produced in different widths. They can be used as a single profile up to approximately 2.5 meters length in linear applications. They can be attached end to end and be used as a continuous light source. Puller ceiling mounting device has been used in order to adhere to the surface of the edge of the frame thoroughly on the ceiling. Light coming from the LED source creates an extremely soft ambiance by passing through the prismatic diffusers.



Code	a	b	c
DFG 20/100	1038mm	35mm	16mm
DFG 20/120	1208mm	35mm	16mm
DFG 20/150	1542mm	35mm	16mm
DFG 60/100	1034mm	75mm	85mm
DFG 60/120	1204mm	75mm	85mm
DFG 60/150	1538mm	75mm	85mm
DFG 80/100	1034mm	95mm	85mm
DFG 80/120	1204mm	95mm	85mm
DFG 80/150	1538mm	95mm	85mm

Code	DFG 20/100 DFG 20/120 DFG 20/150	DFG 60/100 DFG 60/120 DFG 60/150	DFG 80/100 DFG 80/120 DFG 80/150
LED	High efficient Mid-Power LED		
System Power	15 W 18 W 27 W	30 W 36 W 45 W	30 W 36 W 45 W
Light Flux	1,400 lm/m 1,680 lm/m 2,100 lm/m	2,800 lm/m 3,360 lm/m 4,200 lm/m	2,800 lm/m 3,360 lm/m 4,200 lm/m
Colour Temperature	3000 - 4000 - 5000 K		
Voltage	220V - 50Hz		
Body	Aluminum extrusion body 80 micron electrostatic powder coated with paint.		
Diffuser	2,8 mm thick prismatic		
Colour	White or Grey		
Weight	500 gr 600 gr 750 gr	3000 gr 3750 gr 4500 gr	3400 gr 4100 gr 5200 gr

DFG 60 - 80

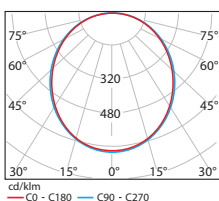

Linear Lighting

DFH Direct-Indirect

IP20

DFH fixtures which can be used as pendant and give direct and indirect light at the same time are produced in 60mm and 80mm widths. They can be manufactured in one piece up to approximately 2.5 meters length in linear applications. They can be attached end to end and be used as a continuous light source. Height of the pendant can be easily adjusted thanks to spring mounting parts.

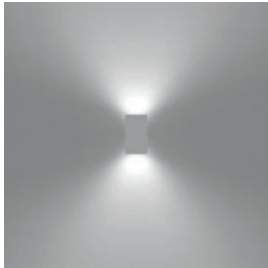
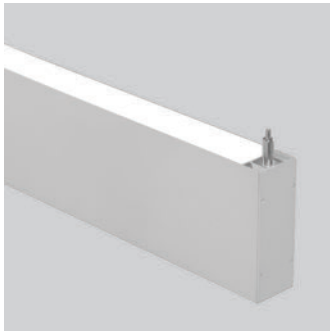

Code	a	b	c
DFH 60/100	1024mm	60mm	138mm
DFH 60/120	1194mm	60mm	138mm
DFH 60/150	1528mm	60mm	138mm
DFH 80/100	1024mm	80mm	183mm
DFH 80/120	1194mm	80mm	183mm
DFH 80/150	1528mm	80mm	183mm

Code	DFH 60/100 DFH 60/120 DFH 60/150	DFH 80/100 DFH 80/120 DFH 80/150
LED	High efficient Mid-Power LED	
System Power	30 W 36 W 45 W	30 W 36 W 45 W
Light Flux	2,800 lm/m 3,360 lm/m 4,200 lm/m	2,800 lm/m 3,360 lm/m 4,200 lm/m
Colour Temperature	3000-4000-5000 K	
Voltage	220V - 50Hz	
Body	1.6 mm thick extrusion aluminum	
Diffuser	1.25 mm thick prismatic diffuser	
Reflector	0,4 mm thick 99,9% pure aluminum (optional)	
End-cap	Aluminum injection	
Colour	White or Grey	

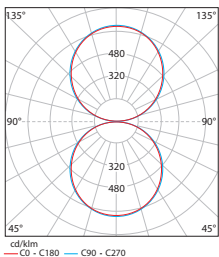

Linear Lighting

TEKNOLINE

IP20



TEKNOLINE is a highly efficient fixture series developed to apply LED technology in lighting of supermarkets, hobby stores, electronics stores as well as production areas that do not require high protection class such as warehouses, hangars and other interior spaces. The light coming from the LED light source is directed to usage areas with high efficiency in fixtures. It creates an extremely comfortable, refreshing and not disturbing environment due to both the quality of light and to low dazzling feature of the light directed from the prismatic diffusers.

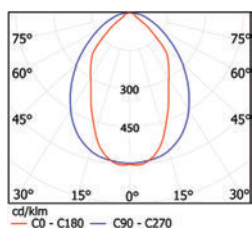
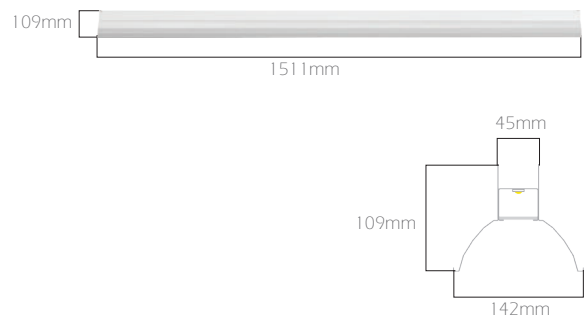

Code	TKL
LED	High efficient Mid-Power LED
System Power	26 W - 35 W
Light Flux	2.400 - 3.150 lm
Colour Temperature	3000 - 4000 - 5000 K
Driver	Osram or Tridonic
Voltage	220V - 50Hz
Body - Reflector	0,6 mm thick DKP sheet steel
Diffuser	2,8 mm thick, 92% transparent acrylic diffuser
Cooler	Cooling from the body surface
Colour	White
Accessory	Pendant, connection apparatus, end-cap
Box Dimensions	12x15x152cm
Weight	4.000 gr



Decorative Fixtures

TWIST

IP20

These fixtures designed with unusual designs for decorative purpose can be used as multi-purpose fixtures. Two different models as with continuous light source and spot are produced. They are provided in black or white according to the requirement of the space.



Line



Spot

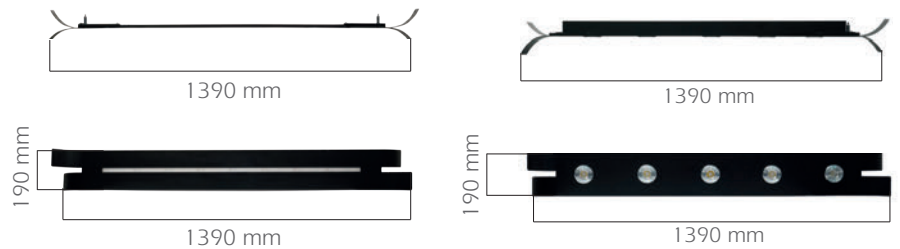

Code	TWS/L	TWS/S
LED	High efficient Mid-Power and COB LED	
System Power	30 W	28 W
Colour Temperature	3000-4000-5000-6000 K	
Voltage	220V - 50Hz	
Body	1 mm DKP sheet steel	
Diffuser	Opal	Prismatic lens
Colour	Black - Grey - White	
Weight	4.600 gr	4.300 gr

SLO



Code	a	b
SLO 60	600 mm	114 mm
SLO 90	900 mm	114 mm
SLO 120	1200 mm	114 mm

IP20

Code	SLO 60	SLO 90	SLO 120
LED	High efficient Mid-Power LED		
System Power	30 W	45 W	60 W
Colour Temperature	3000 - 4000 - 5000 - 6500 K		
Voltage	220V - 50Hz		
Body	Aluminum extrusion		
Diffuser	Opal lens		
Colour	Black - White		
Accessory	Pendant apparatus		
Box Dimensions	62x62x16cm	92x92x16cm	122x122x16

UFO

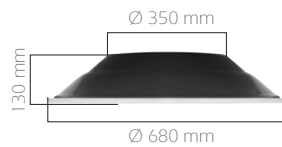

IP20

Code	UFO
LED	High efficient Mid-Power LED
System Power	45 W
Colour Temperature	3000 - 4000 - 5000 - 6500 K
Cooler	Aluminum extrusion cooler
Voltage	220V - 50Hz
Body	ABS plastic
Diffuser	2,8 mm Opal Lens
Colour	Black or White
Accessory	Pendant apparatus

HAP



IP40

Code	HAP
LED	High efficient Mid-Power LED
System Power	48 W
Colour Temperature	3000 - 4000 - 5000 K - RGB
Voltage	220V - 50Hz
Body	2,5 mm thick aluminum, painted with epoxy polyester paint
Diffuser	3 mm thick opal
Colour	Grey
Accessory	Pendant apparatus
Box Dimensions	62x62x10 cm
Weight	5.400 gr

Decorative Fixtures

GEMMA

IP20



Gemma is designed with a different perspective to give a decorative appearance to suspended ceiling fixtures. The pendulum part, height of which can be adjusted as desired, creates a different atmosphere in spaces. Gemma fixtures are highly efficient, energy-saving and do not compromise on aesthetics.

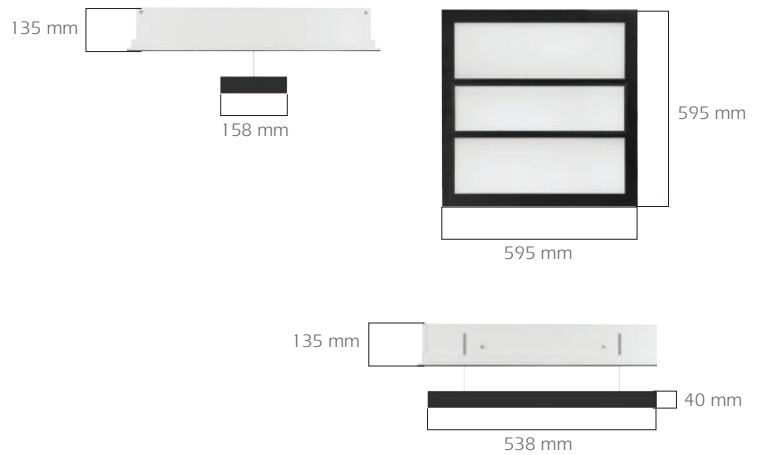

Code	GMA 60
LED	High efficient Mid-Power LED
System Power	48 W
Light Flux	4,000 lm
Colour Temperature	3000 - 4000 - 5000 K
Voltage	220V - 50Hz
Body	0,6mm DKP sheet steel
Diffuser	Opal
Colour	Black or White
Weight	7.400 gr

Decorative Fixtures

BLOOM

IP20



They can be used single while it is possible to create quite different shapes by using side by side and in multi usage. It can be used alone together as using multiple. What a designer can achieve is only limited to his own imagination with multiple usages of color options. They are designed for use in wall and ceiling surfaces. The aesthetic effect it creates on the surface even when the fixtures are deactivated reflects the unique design approach thereof.

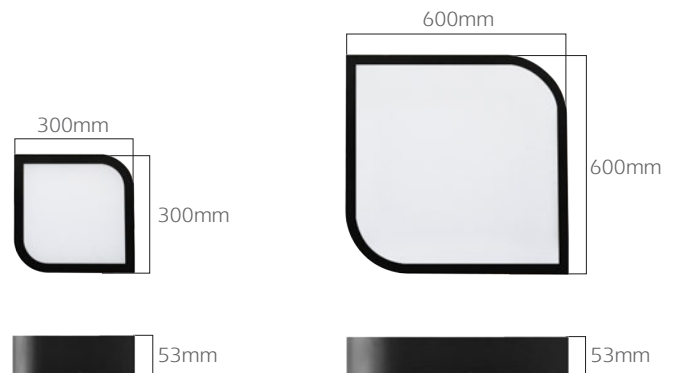

Code	BLM 30	BLM 60
LED	High efficient Mid-Power LED	
System Power	15 W	27 W
Light Flux	1,800 lm	2,607 lm
Colour Temperature	2700-3000-4000-5000K, R-G-B	
Voltage	220V - 50Hz	
Body	Manufactured from DKP sheet steel	
Diffuser	Opal	
Cooler	Cooling from the body surface	
Colour	Optional - RAL colour	
Box Dimensions	31x31x6cm	61x61x6cm
Weight	2.800 gr	4.800 gr

Decorative Fixtures

DOMINOLED

IP20

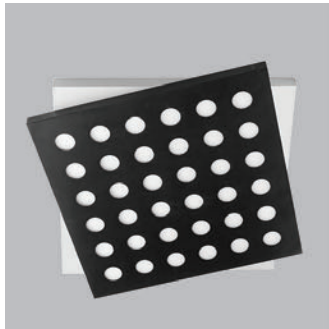

Domino, which can give light from the multi circular structure and which reflects the simplest form of decorative fixtures have been designed for suspended ceiling or surface mounting. The desired effect can be created in spaces by painting in any color. Fixtures using high LED technology give a stylish look to the spaces where they are used due to the soft effect created by opal light.

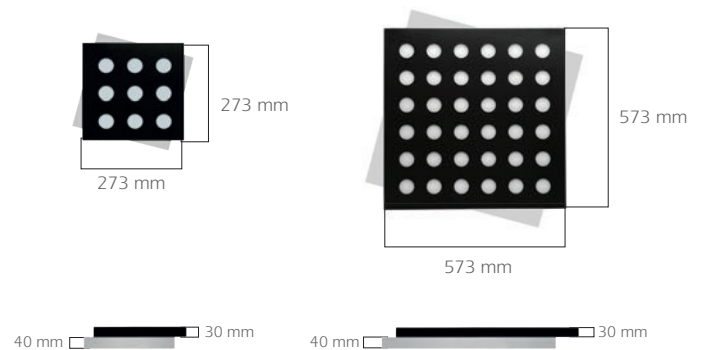

Code	DMN 30	DMN 60
LED	High efficient Mid-Power LED	
System Power	11W	42W
Colour Temperature	3000 - 4000 - 5000 K	
Voltage	220V - 50Hz	
Body	0,6mm DKP sheet	
Diffuser	Opal	
Cooler	Cooling from the body surface	
Colour	Black or White	
Box Dimensions	32x32x8 cm	62x62x8 cm
Weight	3.500 gr	9.000 gr

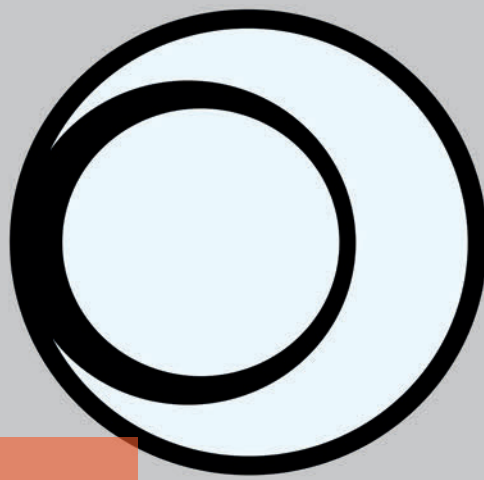

Decorative Fixtures

MOONY

IP20



Moony fixtures changing the uniformity of the circular structure surface mounted fixtures with a simple difference gives a stylish look to the surfaces. Fixture efficiency is at the highest level thanks to LED light source produced by high technology and high-permeable opal material.



Code	MNG
LED	High efficient Mid-Power LED
System Power	25 W
Light Flux	2,400 lm
Colour Temperature	3000 - 4000 - 5000 K
Voltage	220V - 50Hz
Body	Manufactured from 1 mm DKP sheet steel.
Diffuser	Opal
Cooler	Cooling from the body surface
Colour	Optional
Box Dimensions	31x31x8 cm
Weight	3.300 gr



Wall Fixtures

ORIONLED

IP40



LPD-AE fixtures are decorative and aesthetic wall lighting products. Light is spread softly on the surface thanks to the lenses used in the fixture. The fixture has been designed to be suitable for use areas such as modern offices, executive offices as well as many areas. The fixture provides low power consumption and high efficiency by virtue of its LED light source.

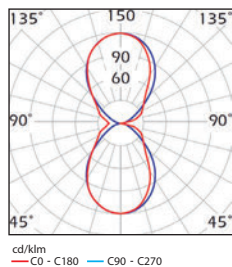

Code	LPD-AE 1	LPD-AE 2
LED	High efficient Mid-Power LED	
System Power	1x18 W	2x18 W
Light Flux	1x1,600 lm	2x1,600 lm
Colour Temperature	3000 - 4000 - 5000 K	
Voltage	220V - 50Hz	
Body	Aluminum extrusion and injection. 80 micron thick electrostatic powder paint.	
Diffuser	3 mm thick prismatic polycarbonates	
Colour	Grey	
Box Dimensions	22x133x10 cm	
Weight	3.400 gr	

Wall Fixtures

FSA

IP40



FSA series products which can be mounted vertically or horizontally on the wall thanks to the minimalist and cornered structure thereof create a dynamic atmosphere in the areas they are used. They are manufactured in a manner to give light in a double or single-sided (both up and down, or only below or above) way. Opal diffusers have been used in order that the fixtures can give light in a pleasant way by not making the eyes tired.

70mm
60mm

77mm
a

Code	a
FSA 118	610 mm
FSA 218	610 mm
FSA 136	1.210 mm
FSA 236	1.210 mm

Code	FSA118	FSA218	FSA136	FSA236
LED	High efficient Mid-Power LED			
System Power	1x18W	2x18W	1x36W	2x36W
Light Flux	1680lm	2x1680lm	3360lm	2x3360lm
Colour Temperature	3000 - 4000 - 5000 K			
Voltage	220V - 50Hz			
Body	1 mm thick DKP sheet steel and 80 micron thick electrostatic powder paint			
Diffuser	5 mm thick opal			
Colour	Grey			
Box Dimensions	8x63x9 cm		8x123x9 cm	
Weight	3.000 gr		6.000 gr	

Wall Fixtures

DAP

IP40

Highly energy efficient DAP can be used in many areas of architecture thanks to its aesthetic wall mounting apparatus. It can be preferred as unidirectional and bidirectional according to the features of the area to be illuminated. LED lamps which can provide narrow and wide angle light can create the desired effect on the surface.

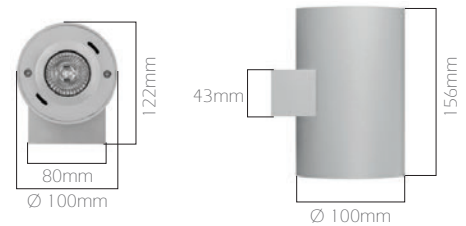
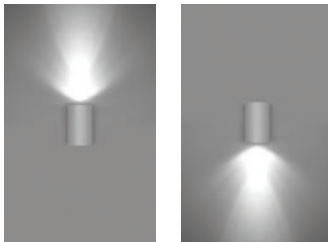

Code	DAP 15	DAP 25
LED	Par 16 Led lamp	
System Power	1x5 W	2x5 W
Colour Temperature	3000 - 4000 - 5000 K	
Voltage	220V - 50Hz	
Body	2.5 mm thick aluminum extrusion, epoxy polyester powder paint	
Colour	Grey	
Box Dimensions	21x22x16,5 cm	
Weight	1.450 gr	



Wall Fixtures

MDW

IP65

MDW brings distinction to the surrounding with its unusual design and advanced technology for both indoor and outdoor lighting applications. Besides combining light efficiency and comfort, this model offers another distinctive feature. It creates a mystic ambiance integrated with the architecture. With its up, down and up/down variations, architectural details on the surface are illuminated with soft light.

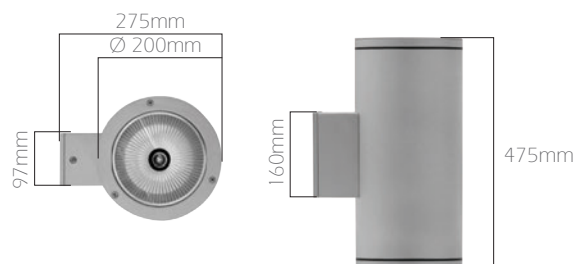
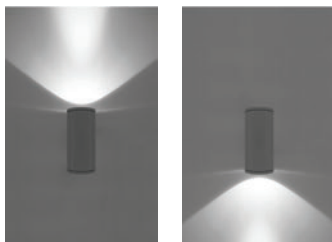
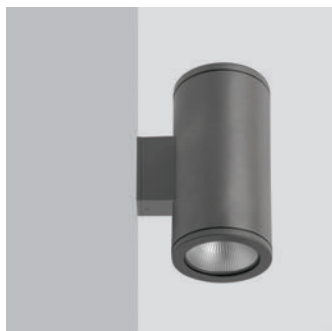

Code	MDW 213
LED	High Efficient COB LED
System Power	2x13 W
Light Flux	2x1.100 lm
Colour Temperature	3000 - 4000 - 5000 K
Voltage	220V - 50Hz
Body	3 mm thick extruded aluminum
Reflector	1 mm thick 99.9% pure aluminum
Glass	5 mm tempered glass
Colour	Grey
Box Dimensions	30x44x22 cm
Weight	8.000 gr



Wall Fixtures

AURALED

IP40

This product is an excellent solution for users with an understanding of proper lighting, the advantages of advanced technology, high quality and aesthetics. The Aura fixtures give users the opportunity to achieve various compositions in lighted areas with the visual effects created on the wall surface.

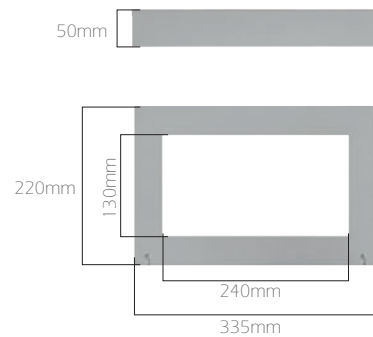
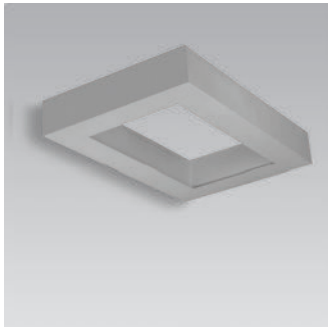

Code	Auraled
LED	High efficient Mid-Power LED
System Power	8 - 15 W
Light Flux	400 - 800 lm
Colour Temperature	3000-4000-5000 K
Voltage	220V - 50Hz
Body	1 mm thick DKP sheet steel
Cooler	Aluminum plate
Glass	Opal
Colour	Grey
Box Dimensions	24X36X6 cm
Weight	1.500 gr

D-LWO

IP54

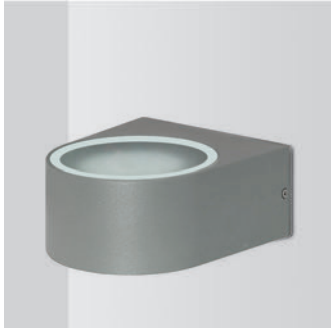

Code	D-LWO
LED	Highly efficient Mid-Power LED
System Power	1x18 W
Colour Temperature	3000-4000-5000 K
Voltage	220 V - 50Hz
Body	Aluminum injection
Cooler	Aluminum extrusion
Glass	3 mm thick tempered, frosted and serigraphic printed
Colour	Grey
Box Dimensions	20x23x10 cm
Weight	1.370 gr

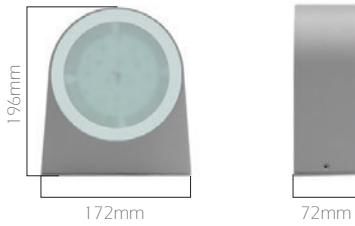

AYL

IP20



Code	AYL
LED	Highly efficient Mid-Power LED
System Power	9 W
Light Flux	850 lm
Colour Temperature	3000 - 4000 - 5000 - 6500 K
Voltage	220V - 50Hz
Glass	Frosted



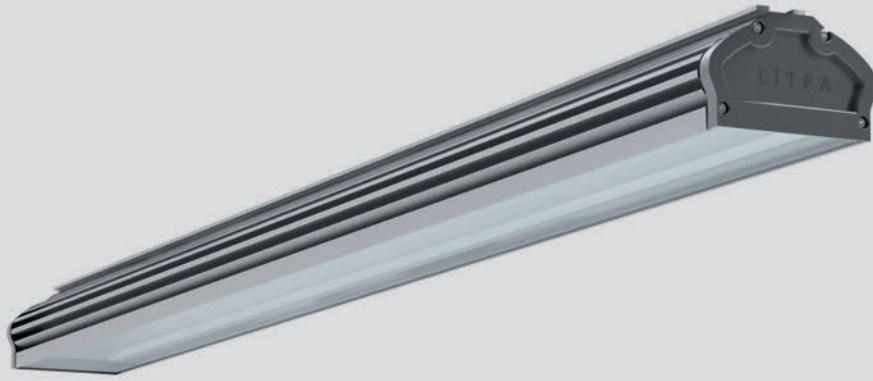

Industrial Lighting

ENDILED

IP66

ENDILED fixtures are high protection class aluminum bodied fixtures produced with extremely high technology. They are suitable for use in many areas of industry, such as production areas, storage areas and particularly in high-ceilinged places. Reflectors produced with 98% optical efficiency by Alanod Miro-Silver technology are used in fixtures in order to ensure high efficiency in narrow-angle models. White Optics reflectors are used in wide-angle products. Heating problems are completely solved thanks to the aluminum body and PCB with high thermal conductivity aluminum.

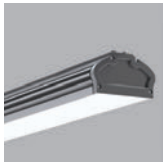
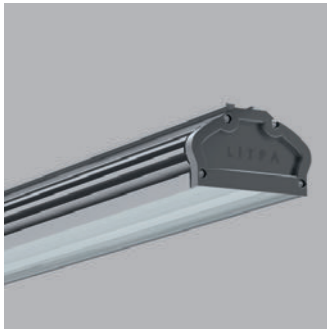

Optional LBS/OP IP20

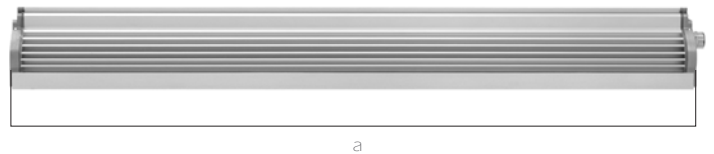
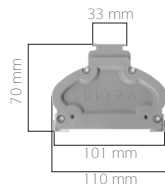

Code	a
LBS 6	686 mm
LBS 9	686 mm
LBS 12	1.286 mm
LBS 20	1.286 mm

Narrow Angle

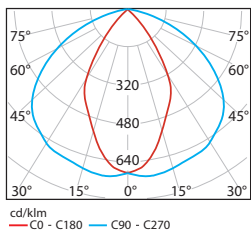

Medium Angle

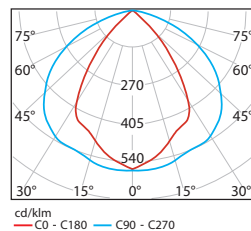

Wide Angle

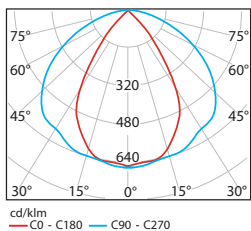

Very Wide Angle

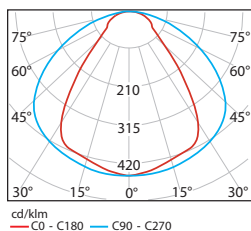

Code	LBS 6	LBS 9	LBS 12	LBS 20
LED	High efficient Mid-Power LED			
System Power	46 W	68 W	92 W	150 W
Light Flux	6.100 lm	9.110 lm	12.100 lm	20.500 lm
Colour Temperature	3.000 - 4.000 - 5.000 - 6.500 K			
Driver	Osram			
Voltage	220 volt - 50hz			
Body	Aluminum extrusion body, end caps are aluminum injection			
Cooler	Aluminum special body structure ensuring quick heat transfer			
Reflector	Miro Silver 4: Bright narrow - medium - wide Miro Silver 5: Matt narrow - medium - wide White Optic: Very wide angle			
Diffuser	Tempered glass or protective film Acrylic prismatic diffuser for soft applications. (IP20)			
Colour	Eloxal matt			
Box Dimensions	75x12x12 cm	135x12x12cm		

Industrial Lighting

ELW

IP65

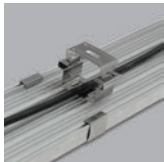

Assembly Accessory

ELW waterproof fixtures have high protection class aluminum extrusion body against water and dust with LED light source. They can be used in many areas such as parking lots, storage areas and other areas for industrial purposes. They provide extra energy savings by reducing the light when it is not needed thanks to their suitability for automation.

ELW120



ELW60

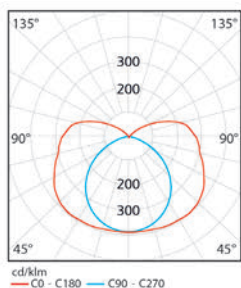

Code	ELW60-15	ELW60-30	ELW120-40	ELW120-60
LED	High efficient Mid-Power LED			
System Power	15 W	30 W	40 W	60 W
Light Flux	1.650lm	3.300lm	4.400lm	6.600lm
Colour Temperature	3000 - 4000 - 5000 - 6500 K			
Cooler	Cooling from the body surface			
Voltage	220 volt - 50hz			
Body	Aluminum extrusion			
Diffuser	Opal - Polycarbonate diffuser			
Colour	Matt anodized			
Accessory	Assembly springs			
Box Dimensions	17x72x12 cm		17x132x12 cm	
Weight	2.100 gr		3.100 gr	







INDEX

A	
AURALED.....	58
AYL.....	59
B	
BLM.....	51
BOLLARD.....	12
BLOOM.....	51
BKA-P.....	12
BYA-AC.....	12
BYA-OP.....	12
D	
DAP.....	56
DFG.....	45
DFH.....	46
DFR/DFR Carisma.....	44
DL.....	23
D-LFA.....	13
D-LFB.....	13
D-LFK.....	13
D-LSD.....	17
D-LWA.....	16
D-LWD.....	16
D-LWK.....	16
D-LWK/mini.....	16
D-LWO.....	59
D-LYD.....	17
DML.....	22
DMN.....	52
D-OLS.....	17
DOMINOLED.....	52
E	
ELD.....	30
ELW.....	61
ENDILED.....	60
F	
FASHIONLED.....	21
FNSB-K.....	36
FNSB-Y.....	37
FNSS-Y.....	41
FSA.....	55
G	
GALAXYLED.....	23
GEMMA.....	50
GMA.....	50
GORDON.....	28
H	
HADES.....	10
HAP.....	49
HERCULED.....	6
HCL.....	6
HFC.....	42
HFC-SR.....	43
HRN.....	28
HYL.....	10

L	
LBS.....	60
LDW.....	8
LEG-OP.....	34
LEG-PR.....	34
LGO.....	33
LGS.....	32
LINEALED.....	8
LKG.....	28
LPD-AE.....	54
LSH.....	14
LSL-OP.....	40
LSL-P.....	40
LSO.....	39
LSS.....	38
LSW.....	9
LYS.....	4
L1671.....	31
L1672.....	31
M	
MDW.....	57
ML110.....	30
MNG.....	53
MOON.....	35
MOONY.....	53
MSH.....	15
O	
OFISLED.....	32-33
OLG.....	35
ORIONLED.....	54
P	
PETROLED.....	18
PGH.....	29
PLG.....	29
PNS.....	27
PTL.....	18
PUNTO.....	26
R	
RINGA.....	5
RLP.....	21
RLK.....	21
RNY.....	5
RTL.....	7
S	
SFR.....	24
SHOPLED.....	20
SHOWLED.....	22
SKYLINE.....	9
SLA.....	25
SLG.....	20
SLO.....	49
SSL.....	26
STREETRAY.....	4

T	
TEKNOLINE.....	47
TKL.....	47
TWIST.....	48
TWS/L.....	48
TWS/S.....	48
U	
UFO.....	49
Y	
YLW.....	11
<hr/>	
8040.....	12
8050.....	12

LİTPA LIGHTING CO.

Office HQ:

Koza Plaza B Blok No:6/20
Teskstilkent - Esenler
İstanbul / TURKEY

Phone: +90 212 438 09 58
Fax: +90 212 438 09 57

Manufacturing:

Haraççı - Hadımköy Yolu
Cad. No:15 Haraççı Mah.
Arnavutköy - İstanbul / TURKEY

Phone: +90 212 683 09 87
Fax: +90 212 683 09 92

Ankara Office:

Ziyabey Cad. Kardelen Apt.
No: 30/14
Balgat - Ankara / TURKEY

Phone: +90 312 284 58 05
tayfunceylan@litpa.com

www.litpa.com

